

**OFF-
ROAD
LIVIN'**

can-am

**2021 ACCESSORIES
EUROPE, MIDDLE EAST AND AFRICA EDITION**

TRAXTER

YOUR JOB. OUR ACCESSORIES. LET'S GET IT DONE.



FIT & COMPATIBILITY



FOR US, INNOVATION IS A NO BRAINER. ALL OUR ACCESSORIES WORK TOGETHER, RIGHT OUT OF THE BOX. SO TAKE YOUR PICK. THEN PICK SOME MORE.

STYLE & VISION



WE'VE UPPED THE ANTE ON ACCESSORIES. NOT JUST DESIGNED TO LOOK GOOD, BUT PERFORM RIGHT FOR REAL RIDERS. ALL KILLER, NO FILLER.

QUALITY & RELIABILITY



OUR CAN-AM ACCESSORIES ARE MADE RIGHT THE FIRST TIME. AND TO TOP IT OFF WE THREW IN A 2-YEAR WARRANTY. YOU'RE WELCOME. INSTALL THEM YOURSELF OR AT AN AUTHORIZED DEALER.

can-am

**BRP 2-YEAR
LIMITED WARRANTY**

For new Can-Am accessories, genuine parts, and co-branded products sold through BRP. Includes items installed by you or an authorized BRP dealer.

2021

can-am
TRAXTER

ACCESSORIES

Built Inspirations	6
Roofs	12
Hard Cabs	15
Soft Cabs	16
Windshields & Mirrors	17
Doors	21
Rear Wind Protection	23
Skid Plates	25
Bumpers & Guards	26
LinQ: Easy On, Easy Off Cargo	33
Cargo & Storage	39
Racks & Holders	44
Lights	48
Audio & Communication Systems	52
Electrical & Electronic	54
Winches & Hitches	57
Seats	60
Performance	61
Track Systems	65
Promount Plows	69
Covers & Add-Ons	75
Tires & Rims	76

CAN-AMOFFROAD.COM

© 2020 Bombardier Recreational Products Inc. (BRP). All rights reserved. ®, TM and the BRP logo are trademarks of BRP or its affiliates. CARLISLE is a trademark of Carlisle Companies. CHAMUDE and HIPORA are registered trademarks of Kolon Industries, Inc. CLARINO is a trademark of Kuraray Co. Ltd. COOLMAX and THERMOLITE are registered trademarks of INVISTA for durable fabrics. DRIRELEASE is a registered trademark of Optimer Inc. FOX is a registered trademark of Fox Racing Canada. GARMIN and MONTANA are registered trademarks of Garmin Ltd. iPod is a registered trademark of Apple Inc. KOLPIN, GUN BOOT and IMPACT are registered trademarks of Kolpin Powersports Inc. KVB is a registered trademark of Kayaba. MicroSD is a registered trademark of SD Card Association. Mud Lite XTR and SS312 are trademarks of ITP Tires. NEXT G-1 VISTA is a trademark of Next Camo, LLC. NGK is a registered trademark of NGK Spark Plugs, Ltd. PRIMALOFT GOLD and PRIMALOFT BLACK are registered trademarks of Albany International Corp. TEFLON, TEFLON HT and KEVLAR are trademarks of E.I. DuPont de Nemours & Co. TWINAIR is a trademark of Twin Air USA. UNI is a trademark of UNIFILTER Inc. VELCRO is a registered trademark of Velcro Industries. WARN is a trademark of Warn Industries Inc. YUASA is a registered trademark of YUASA Batteries Inc. ZILLA and BIGHORN 2.0 are trademarks of Maxxis. SCOTT is a trademark of Scott Sports SA. The following trademarks are the property of their respective owners: BLUETOOTH, CREE, DURO, DWIT, HELLA, ITP, KENDA, MOSSY OAK, RAM, SUR LAST, VISION, XPS and YOSHIMURA. Baja Designs is a registered trademark of Baja Designs Inc. SS POWERSPORTS is a trademark of SS Power Sports LLC. Some models depicted herein may include optional equipment. Prices, if shown, are based on Manufacturer Suggested Retail Prices. Dealers may sell for a different price. For Canada and US, taxes are not included. Depending on location, products are distributed by BRP US Inc., Bombardier Recreational Products Inc., BRP European Distribution SA, BRP Finland Oy, BRP Australia Pty Ltd, or BRP Brasil Motorsports LTDA. BRP reserves the right, at any time, to discontinue or change specifications, prices, designs, features, equipment without incurring obligation.

**EXPERT
CHOICE**

LOOK FOR THIS LOGO THROUGHOUT THE CATALOGUE FOR EXPERT RECOMMENDATIONS ON INNOVATIVE, MUST-HAVE, ENTHUSIAST-READY PARTS AND ACCESSORIES THAT WILL HELP YOU CUSTOMIZE YOUR PERFECT OFF-ROAD MACHINE.

EXPERTLY-CHOSEN PACKAGES

ADD THE ACCESSORIES YOU WANT WITH 3 LEVELS OF UPGRADES: **STARTER**, **ADVANCED**, AND **PEAK**. OR MIX AND MATCH OPTIONS—IT'S YOUR RIDE.

STARTER

Essential, recommended upgrades to immediately enhance any Can-Am vehicle.

ADVANCED

The best all-round, do-anything upgrades that have proven popular with experienced riders and new owners alike. Transform your Can-Am for the years of riding ahead.

PEAK

Limits are for other people: build your Can-Am Off-Road vehicle to overcome bigger obstacles & ride through larger adventures.



CAN-AM ACCESSORIES FOR GROWN-UP FUN.

TRAXTER PRO

EXPLORE

STARTER

715005276	ProVent Windshield	p. 20
715007081	Rear Polycarbonate Windshield	p. 23
715005754	Front Bumper	p. 27
715005777	Xtreme Front Bumper Plates	p. 27
715005774	Front Corner Protector	p. 27
715006012	Rear Bumper	p. 29
715002459	Side Mirror	p. 20

ADVANCED

715006325	Soft Doors	p. 22
715006001	Fender Flares	p. 30
715003873	Headache Rack	p. 40
715005415	Cargo Bed Protectors & Tie Rails	p. 29
715003870	Adventure Roof Rack	p. 44
715004778	LinQ 8 Gal Cooler Box	p. 36

PEAK

715006697	Skid Plate Kit	p. 25
715002019	Complete Overhead Audio System	p. 53
715004007	39" (99 cm) Double Stacked LED Light Bar (270W)	p. 48

*Note that price does not include installation requirements and that part numbers may vary depending on vehicle model.

EXPLORE

HARD WORK

HUNTING

WINTER

YOU CAN FINANCE THE PURCHASE OF ACCESSORIES with the purchase and financing of your Traxter. Ask your dealer for all the details.

YOUR WORK STARTS HERE:
OUTFIT THE CAN-AM TRAXTER
TO HAUL, CARRY, AND DO EVEN MORE.



TRAXTER MAX

YOUR ULTIMATE HUNTING RIG
IS WITHIN REACH—IT'S JUST
A MATTER OF OUTFITTING
IT TO YOUR NEEDS.



TRAXTER

HARD WORK

STARTER

715003038	Sport Roof	p. 13
715002433	Half Windshield	p. 19
715006316	Half Doors (Max)	p. 22
715002423	Deluxe Headache Rack	p. 40
715002464	LinQ Tailgate Extension/Divider	p. 37

ADVANCED

715005754	Front Bumper	p. 27
715005777	Xtreme Front Bumper Plates	p. 27
715006012	Rear Bumper	p. 29
715002421	Bed Wall Extenders	p. 40
715003665	3.5" (9 cm) Flood LED Lights	p. 49

PEAK

715006064	LinQ Front Rack	p. 38
715004282	LinQ Low Profile Basket	p. 36
715007077	Rear Cargo Light	p. 51
715004905	Rear View Mirror & Camera Monitor	p. 54
715003095	Overhead Front Audio System	p. 53
715006416	Can-Am HD 4500 Winch	p. 57

*Note that price does not include installation requirements and that part numbers may vary depending on vehicle model.

HUNTING

STARTER

715002430	Sport Roof	p. 13
715002442	Flip Windshield - Hardcoated	p. 19
715006314	Half Doors	p. 22
715002851	Rear Wind Screen	p. 24
715002423	Deluxe Headache Rack	p. 40
715005466	LinQ Tool & Gun Holder	p. 45
715005449	Hanging Storage Box Kit	p. 39
715005409	Fender Flares	p. 30

ADVANCED

715005410	Rancher Front Bumper	p. 28
715003879	LinQ 12 Gal (45L) Cargo Box	p. 36
715003870	Adventure Roof Rack	p. 44

PEAK

715006696	Skid Plate Kit	p. 25
715003617	Front Rancher Body Side Protectors	p. 29
715002569	Rock Sliders	p. 31
715002935	4" Round LED Lights	p. 49
715007077	Rear Cargo Light	p. 51

*Note that price does not include installation requirements and that part numbers may vary depending on vehicle model.



THRIVE IN THE DEEPEST SNOW—FOR WORK OR PLAY. YOUR CAN-AM WAS BORN TO BE A WINTER WARRIOR.



TRAXTER

WINTER

STARTER

715002432	Full Windshield - Hardcoated	p. 19
715006325	Soft Doors	p. 22
715007081	Rear Polycarbonate Window	p. 23
715005904	Defrost, Heat & Ventilation System	p. 56

ADVANCED

715006821	Fender Flares	p. 30
715003873	Headache Rack	p. 40
715003028	Bed Tool Box	p. 43
715002934	15" (38 cm) Double Stacked LED Light Bar	p. 48
715002456	Light Rack	p. 51
715003665	3.5" (9 cm) Flood LED Lights	p. 49
715004905	Rear View mirror & Camera Monitor	p. 54
715003837	Heated Steering Wheel	p. 56
715006112	Heated Seat Cover (Driver)	p. 56

TRACKS

715005103	Apache 360LT Tracks	p. 67
715005492	Apache 360 LT Tracks Mounting Kit	p. 67

PLOW

715006111	Warn VRX 45-S Winch	p. 57
715006301	Can-Am ProMount Flex2 72" Plow Kit	p. 70

*Note that price does not include installation requirements and that part numbers may vary depending on vehicle model.

ROOFS

MADE WITH HIGH-QUALITY MATERIALS DESIGNED IN CONCERT WITH YOUR CAN-AM, OUR ROOFS CREATE A STRONG, LIGHT, RESILIENT BARRIER FROM THE ELEMENTS.



BUILT FOR YOUR VEHICLE
 Engineered with the same design, fit, finish, and built-to-last quality found across our lineup.



↔ **MAKE IT YOURS**

Compatible with other accessories to make your vehicle as unique as you are. Lights, windshield, doors, roofs, bumpers and more.

100% INTEGRATED

into the design of all Can-Am accessories.

EXPERT CHOICE

SPORT ROOF

- Robust injection-molded polypropylene construction.
- Provides added protection for rider and passenger from the elements.

Traxter
715002430

Traxter MAX
715003038

DELUXE SPORT ROOF

- Complete roof kit provides extra driver and passenger protection and also diminishes noise within the cab.
- Perfect fit and finish thanks to the seal kit and the liners included.
- Rear Roof Liner is not compatible with Soft Rear Panel.

Traxter
Kit includes:
 • Sport Roof
 • Sport Roof Seal Kit
 • Front Roof Liner
 • Rear Roof Liner
715002511

Traxter MAX
Kit includes:
 • Sport Roof
 • Sport Roof Seal Kit
 • Front Roof Liner
 • Rear Roof Liner
715003039



SPORT ROOF SEAL KIT

(Not illustrated)
 • Necessary when installing individual cab components with Sport Roof or when installing the Front and Rear Roof Liners.

Traxter
715003126

Traxter MAX
715003583



BIMINI ROOF WITH SUN VISOR

DESIGN YOUR OWN HARD CAB OR SOFT CAB.

PICK THE ACCESSORIES OF YOUR CHOICE AND BUILD OR COMPLETE YOUR OWN CAB.



100% modular components designed to work together:

- ROOFS P. 12
- WINDSHIELDS P. 17
- DOORS P. 21
- REAR WINDOWS P. 23



BIMINI ROOF WITH SUN VISOR

- Heavy-duty canvas made of UV-resistant polyester.
- Soft Top comes with a hard visor that allows for storage of rolled-up soft top and mounting of Light Rack.
- Quick and easy installation.

Traxter

- Not compatible for use with soft and rigid full doors.

■ 715003418 • Black

Traxter MAX

■ 715003030 • Black



FRONT ROOF LINER

- Vehicle enhancement.
- Integrates seamlessly with roof-mounted light switch.
- Required for installation of roof-mounted lights and of the audio systems.
- Allows a better integration of Windshield Wiper & Washer Kit.
- Seal Kit necessary when installing with Sport Roof (715003038 or 715002430).

Traxter, Traxter MAX
715003098



REAR ROOF LINER

- Quick and easy vehicle enhancement.
- Allows better integration of other accessories installed on the roof.
- Seal Kit necessary when installing with Sport Roof.

Traxter

- Needs to be installed with Sport Roof (715002430).

715006334

Traxter MAX

- (Not illustrated)
- Needs to be installed with Sport Roof (715003038).

715006391



NEW CLEAR RIGID CAB

Included:

- Clear Rigid Doors
- Sport Roof
- Glass Windshield
- Rear Polycarbonate Window
- Sport Roof Seal Kit

Defender

715007269

Defender MAX

715007270

CAB ENCLOSURE

- Rigid cab enclosure ideal for Traxter XT vehicles that come stock with a roof, but also fits on Base and DPS models with the addition of a roof.
- Offers good driver and passenger protection from the elements.
- Not EC compliant.

Included:

- Flip Glass Windshield
- Full Doors with Power Windows
- Rear Window, Insulation Acoustic Kit
- Window Harness
- Roof Power Cable Kit
- Hard Enclosure Roof Seal Kit

Traxter XT

715006333

PREMIUM RIGID CAB ENCLOSURE

- Provides driver and passenger with the best protection from the elements and the cold, and features the most complete top-of-the-line accessories our product lineup has to offer.
- Not compatible with X mr models.
- Not EC compliant.

Included:

- Deluxe Sport Roof Kit
- Flip Glass Windshield with Wiper and Washer Kit
- Full Doors with Power Windows
- Rear Glass Window with Sliding Panel
- Thermal Insulation Kit
- Rear Full Doors
- Wiper and Powered Windows Cable
- Roof Power Cable
- Rigid Cab Seal Kit

Traxter MAX

715006332

Included:

- Deluxe Sport Roof Kit
- Flip Glass Windshield with Wiper and Washer Kit
- Full Doors with Power Windows
- Rear Glass Window with Sliding Panel
- Thermal Insulation Kit
- Wiper and Powered Windows Cable
- Roof Power Cable
- Rigid Cab Seal Kit

Traxter

715006330



SOFT CABS



↔
Pick your perfect cab with Can-Am exclusive interchangeable enclosure accessories.

SOFT CAB ENCLOSURE

- Protection for rider and passenger from the elements.
- Not compatible with X mr models.

- Included:**
- Bimini Roof with Sun Visor (715002918 - Not sold separately / 715003030)
 - Full Windshield - Hardcoated
 - Soft Doors
 - Soft Rear Panel

Traxter (2019 & prior)
■ 715002917 • Black

Traxter (2020 & up)
■ 715006327 • Black

Traxter MAX (2019 & prior)
■ 715003032 • Black

Traxter MAX (2020 & up)
■ 715006317 • Black



HYBRID CAB ENCLOSURE

(Not illustrated)

- Included:**
- Sport Roof
 - Full Windshield - Hardcoated
 - Soft Doors
 - Rear Polycarbonate Window
 - Rear Wind Protection Installation Seal Kit

Traxter
■ 715006722 • Black

Traxter MAX
■ 715006723 • Black

CAB INSULATION KIT

(Not illustrated)

- Neoprene insulation kit: A must for cold riding conditions.
- Helps keep the cold outside the cabin and the heat inside when the vehicle is equipped with a complete cab enclosure (soft or rigid).
- Standard on XT Cab models 2018 and up.

Traxter (2019 & prior)
715004911

WINDSHIELDS

ENHANCE THE FIT, LOOK, AND COMFORT OF YOUR TRAXTER WITH A FACTORY-DEVELOPED WINDSHIELD TO PROTECT FROM THE ELEMENTS, THE DUSTY TRAILS, DEEP MUD HOLES, AND ROCKY TERRAIN.



☺
MAKROLON[®] COATING
Our Full Windshield – Hardcoated is made of high-impact-resistant Makrolon[®] hardcoated polycarbonate to ensure a long life.



FLIP GLASS WINDSHIELD

Allows you to quickly adapt to changing conditions by adjusting the windshield as you go.



100% INTEGRATED

Your Can-Am's standard profiled cage allows our accessories to install easily, with a perfect fit.



FLIP GLASS WINDSHIELD

- Curved and laminated glass full windshield in metal frame.
- Provides excellent optical clarity.
- Seals firmly against the cage and protects rider and passenger from the elements while allowing for controlled air flow.
- 3-position flip can be set at fully closed, ¼ open, or fully open.

Traxter, Traxter MAX
715002942

- Gas-shock-assisted operation and pivots on 2 hinges located at the top of the windshield.
- Ideal for muddy conditions.
- Can be used with Windshield Wiper & Washer Kit (715001638).
- Not EC compliant.

FLIP WINDSHIELD – HARDCOATED

- High-impact-resistant Makrolon¹ hardcoated polycarbonate full windshield in metal frame.
- Provides excellent optical clarity and better abrasion resistance.
- Seals firmly against the cage and protects rider and passenger from

- the elements while allowing for controlled air flow.
- 3-position flip can be set at fully closed, ¼ open, or fully open.
- Gas-shock-assisted operation.
- Ideal for muddy conditions.

Traxter, Traxter MAX
715002442



GLASS WINDSHIELD

- Curved and laminated glass full windshield in metal frame.
- Seals firmly against the cage and protects rider and passenger from the elements while providing excellent optical clarity.

Traxter, Traxter MAX
715001303

- Must be used with Windshield Wiper & Washer Kit (715001638) to maintain clear visibility during severe riding conditions.
- Not EC compliant.



FLIP GLASS WINDSHIELD WITH WIPER & WASHER KIT

- Curved and laminated glass full windshield in metal frame.
- Provides excellent optical clarity.
- Seals firmly against the cage and protects rider and passenger from the elements while allowing for controlled air flow.
- Flip windshield can be set fully closed or fully open according to your preference.

Traxter, Traxter MAX
715002441

- Ideal for muddy conditions.
- Gas-shock-assisted operation and pivots on 2 hinges located at the top of the windshield.
- Single-speed wiper with washer fluid dispenser.
- Requires Wiper & Power Cable (710004462) and Power Cable (715003094).
- Not EC compliant.

WINDSHIELD WIPER & WASHER KIT

- An ideal way to keep your windshield clear in rain, or while riding through mud and water.
- Includes single-speed wiper, washer fluid dispenser and windshield frame mount.
- Must be used with the Glass Windshield (715001303) or Flip Glass Windshield (715002942).
- Requires Wiper & Power Windows Cable (710004462) and Power Cable (715003094).
- Not EC compliant.

Traxter, Traxter MAX
715001638



WIPER & POWER WINDOWS CABLE

- (Not illustrated)
- Required to install Full Doors with Power Windows (715006331) and/or Windshield Wiper & Washer Kit (715001638).
- Necessary if you want to build your own cab enclosure from modular components.

Traxter, Traxter MAX
710004462

FULL WINDSHIELD – HARDCOATED

- High-impact-resistant Makrolon¹ hardcoated polycarbonate full windshield.
- Provides excellent optical clarity and better abrasion resistance.
- Protects driver and passenger from the elements.
- Quick and easy tool-less installation or removal.

Traxter, Traxter MAX
715002432



FULL WINDSHIELD

- High-impact-resistant durable polycarbonate full windshield.
- Formulated to be non-yellowing, non-crazing, non-cracking with excellent UV resistance and optical clarity.
- Protects driver and passenger from the elements.
- Quick and easy tool-less installation or removal.

Traxter, Traxter MAX
715002431



HALF WINDSHIELD

- High-impact-resistant durable polycarbonate half windshield.
- Formulated to be non-yellowing, non-crazing, non-cracking with excellent UV resistance and optical clarity.
- Protects driver and passenger from the elements.
- Features reverse angle lip to deflect air flow.
- Quick and easy tool-less installation or removal.
- Not compatible with Soft Doors.

Traxter, Traxter MAX
715002433





SIDE WIND DEFLECTORS



ENHANCED UTILITY, LOOKS, AND PROTECTION FROM THE ELEMENTS ON JOBSITES AND TRAIL RIDES ALIKE.

EXPERT CHOICE

PROVENT WINDSHIELD

- High-impact-resistant Quantum¹ hardcoated polycarbonate full windshield.
- Optimal performance with Full Cab Enclosure.
- Controllable vents to manage air flow.
- Channels air into the cabin, defogs windshield, fully closes to eliminate air flow.
- 2 lower vents and one upper vent (pre-filter installed).
- Provides excellent optical clarity and better abrasion resistance.
- Protects driver and passenger from the elements.
- Quick and easy tool-less installation or removal.
- Not compatible with wiper kits.

Traxter, Traxter MAX
715005276

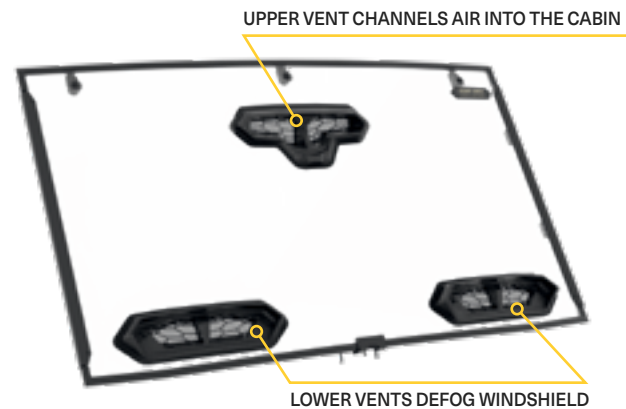

SIDE WIND DEFLECTORS

- Clear polycarbonate air deflectors mount on each side of the cage.
- Not compatible with Full Doors.
- Sold in pairs.
- Compatible with all windshields.

Traxter, Traxter MAX
715005081

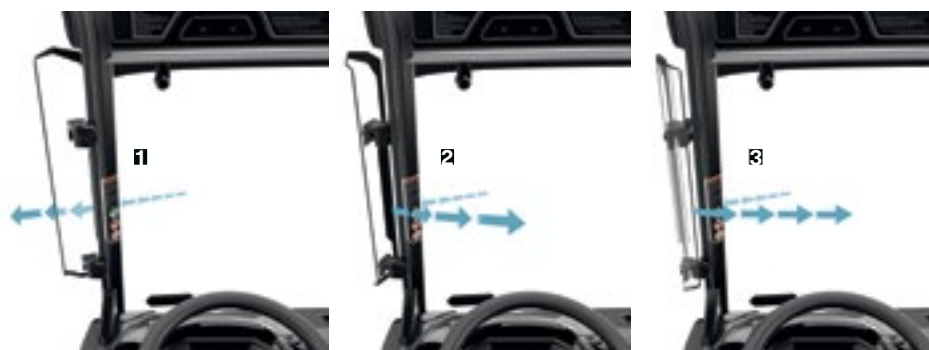

- Can be adjusted at three different positions for cabin air flow control when a full windshield is installed:
- 1. Outside deflection to reduce cabin air flow and turbulence.
- 2. Inside deflection to increase air flow in the cabin.
- 3. Windshield ventilation to reduce fog.

SIDE MIRROR

- Molded heavy-duty aluminum mirror.
- Stays in place on rough trails.
- Ball-joint design for steady multi-angle adjustment and outstanding vision.
- Can be used with or without roof, windshield or door.
- Not for road use.
- Fits either side.
- Sold individually.

Traxter, Traxter MAX
715002459



PANORAMIC CENTER MIRROR

- Wide-angle convex mirror.
- Offers enhanced visibility.
- Can be used with or without roof or windshield and with cab enclosures.

Traxter, Traxter MAX
715003638



TOOL-LESS REMOVABILITY
Once installed, our doors are easy to remove on hot and sunny days.

100% INTEGRATED
Your Can-Am's standard profiled cage allows our accessories to install easily, with a perfect fit.

FULL DOORS WITH POWER WINDOWS

- Made from robust high-density polyethylene.
- Offer excellent protection from the elements.
- Easy to remove on hot and sunny days.
- Lockable doors with convenient integrated storage areas.
- Doors' curved design provides even more roominess.
- Rear hinge wide opening for ease of ingress/egress in the cockpit.
- Power window delivers added ventilation.
- Compatible with all BRP windshields.
- Require Wiper & Power Windows Cable (710004462), Roof Power Cable (715003094) and Seal Kit (715003126).

Traxter, Traxter Max
715006331



EXPERT CHOICE

NEW CLEAR RIGID DOORS

- Sturdy and compact steel frame doors for a robust yet open field of view.
- Lower hardcoated polycarbonate transparent panel maximizes visibility around your unit.
- Upper portion composed of 2 tempered-glass sliding windows for unmatched air circulation and versatility.
- EC and ROHVA compliant for optimal safety, allowing you to remove the stock side protection bar for increased cabin space.
- Sealed contour allows for improved rider comfort in all weather.
- Lockable doors, for peace of mind.

Defender
715006261

Defender MAX
715006262



REAR FULL DOORS

- Made from robust high-density polyethylene.
- Offer excellent protection from the elements.
- Easy to remove on hot and sunny days.
- Lockable doors with convenient integrated storage areas.
- Curved design provides even more roominess.
- Rear hinge opens wide for ease of ingress/egress in the cockpit.
- Pop-out window delivers added ventilation.
- Require Front Doors (715006331), Wiper and Power Windows Cables (710004462), Power Cable (715003094) and Sport Roof Seal Kit (715003583).

Traxter MAX
715006329



HALF DOORS

- Half doors made of plastic.
- Metal frame for a higher level of fit and finish and rigidity.
- Rear hinge wide opening for ease of ingress/egress in the cockpit.
- Interior pockets and liners for more protection.

Traxter (2 doors)
715006314

Traxter MAX (4 doors)
715006316



SOFT DOORS

- Bestop designed soft doors for Can-Am Traxter.
- Weather-resistant soft doors reinforced with steel frame offer good protection from the elements.
- Made of heavy-duty UV-resistant canvas for excellent resistance to tear and abrasion.
- Rear hinge wide opening for ease of ingress/egress.
- Zip-down windows made of laminated polished vinyl material for added ventilation.
- Easily removable on hot sunny days.
- Compatible with roofs and mirrors.
- Soft Door Installation Kit (715006238 / 2X for MAX) is required for installation of 2019 & prior doors, on 2020 Traxter models.

Traxter (2 doors)
■ 715006325 • Black

Traxter MAX (4 doors)
■ 715006322 • Black

Traxter, Traxter MAX (Front passenger door only)
■ 715006676 • Black



REAR WIND PROTECTION

REAR GLASS WINDOW WITH SLIDING PANEL

- Made of high-strength tempered glass.
- Ideal for preventing backdraft of dust or rain in harsh environments.
- Sliding panel for enhanced ventilation.
- Quick and easy installation.
- Sport Roof (715002430 or 715003038) required for installation.
- Not compatible with snorkel kit.

Traxter, Traxter MAX (except X mr models)
715007080



REAR GLASS WINDOW

- Made of high-strength tempered glass.
- Ideal for preventing backdraft of dust or rain in harsh environments.
- Quick and easy installation.
- Sport Roof (715002430 or 715003038) required for installation.
- Not compatible with snorkel kit.

Traxter, Traxter MAX (except X mr models)
715007079



REAR POLYCARBONATE WINDOW

- High-impact-resistant polycarbonate window.
- Ideal for preventing backdraft of dust or rain in harsh environments.
- Quick and easy installation.
- Sport Roof (715002430 or 715003038) required for installation.
- Not compatible with snorkel kit.

Traxter, Traxter MAX (except X mr models)
715007081





SOFT REAR SCREEN

SOFT REAR PANEL

- Weather-resistant soft rear panel with steel frame offers good protection from the elements.
- Made of heavy-duty UV-resistant canvas for excellent resistance to tear and abrasion.
- Tinted window made of laminated polished vinyl material.
- Resists cold cracking to -22 °F (-30 °C).
- Installs quick and easily on roll cage.
- Not compatible with the Bimini Roof with Sun Visor

Traxter, Traxter MAX (2019 & prior)

■ 715002920 • Black

Traxter, Traxter MAX (2020 & up)

■ NEW 715006680 • Black



REAR WIND SCREEN

- Full rear mesh screen reduces windshield backdraft for added cabin comfort.
- Installs quick and easily on roll cage.
- White Can-Am logo at top, to help maintain clear view.

Traxter, Traxter MAX
715002851

SOFT REAR WINDOW

- Clear, flexible window made of see-through vinyl.
- Resists cold cracking to -4 °F (-20 °C).
- Blocks windshield backdraft or dust and rain from entering, for added cabin comfort.
- Installs quick and easily on roll cage.
- White Can-Am logo at top, to help maintain clear view.

Traxter, Traxter MAX
715003249

ALUMINUM SKID PLATES

For ultimate durability and strength, all our Aluminum Skid Plates are made with High Strength 5052 H32 Aluminum 3/16" (4.5 mm) thick.

- ✓ Ultimate durability
- ✓ High strength

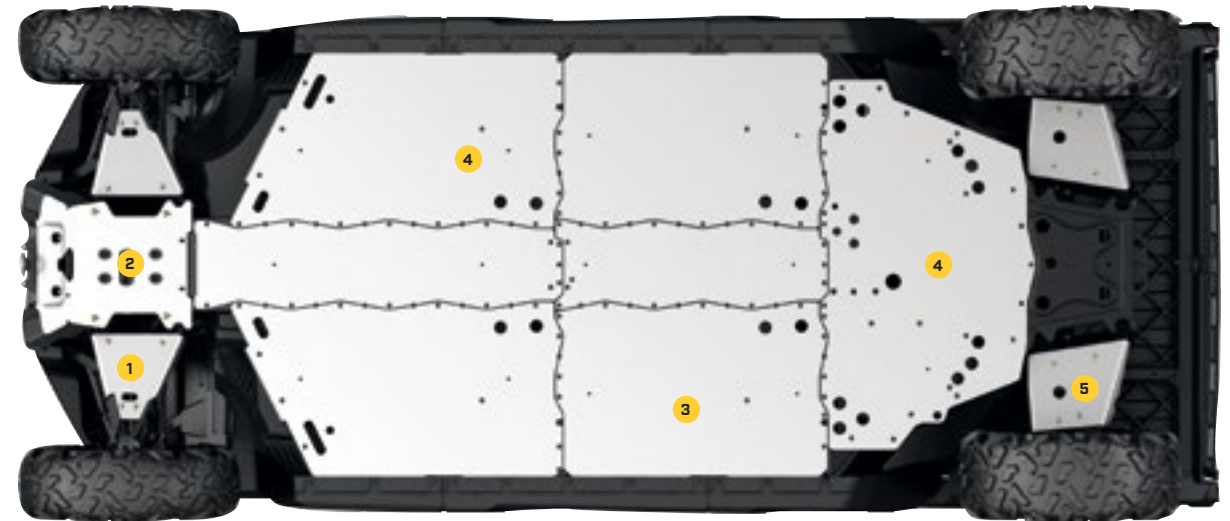

TRAXTER, TRAXTER MAX

2019 & PRIOR		2020 & UP		
Base, DPS, XT, XT-P, XT Cab 2017 & prior & Hunting Edition	XT Cab 2018-2019, Lonestar Edition & X mr	Base, DPS (HD5, HD8, HD10 T-cat 2020), XT (HD8) & PRO T-cat (HD8, HD10)	Pro (DPS, XT), DPS (HD10 except T-cat 2020), XT (HD10), XT-P, XU (HD10 T-cat 2021)	XT Cab, Hunting Edition, Lonestar Edition, Limited & X mr

FULL PROTECTION KIT

	2019 & PRIOR	2020 & UP	2020 & UP	2020 & UP	2020 & UP
ALUMINUM SKID PLATE PROTECTION KIT	715003711 (except MAX)	715006977 (3up)	715006694 (except MAX)	715006696 (3up)	715006979 (3up)
	715003712 (MAX only)	715006978 (MAX)	715006695 (MAX only)	715006697 (MAX & PRO)	715006980 (MAX)

INDIVIDUAL ALUMINUM SKID PLATES

	2019 & PRIOR	2020 & UP	2020 & UP	2020 & UP	2020 & UP
1 FRONT A-ARM PROTECTORS • Extra underside protection for your vehicle's steering mechanism and suspension (A-Arm). • Sold in pairs. • Not compatible with Apache Track Systems.	715002444	715006975	715002444	715004387	715006975
2 FRONT SKID PLATE • Protects the front underside of your vehicle when riding in rough terrain conditions. • Adds style to the front of your vehicle.	715002447	715002447	715002447	715002447	715002447
3 CENTRAL SKID PLATE • Central skid plate kit includes central and lateral skid plates. • Ultra-durable protection for the underside of your vehicle. • Makes work easy in more demanding terrain. • Must be used with Underbelly Skid Plate Kit.	715003467 (MAX only)	715003467 (MAX only)	715003467 (MAX only)	715003467 (MAX & PRO only)	715003467 (MAX only)
4 UNDERBELLY SKID PLATE KIT • Ultra-durable protection for the underside of your vehicle. • Makes work easy in more demanding terrain. • Kit includes lateral and rear skid plates.	715002446	715002446	715006197	715006197	715006197
5 REAR A-ARM PROTECTORS • Extra underside protection for your vehicle's suspension (A-Arm). • Sold in pairs. • Not compatible with Apache Track Systems.	715002445	715006976	715002445	715004388	715006976

BUMPERS

THE STRENGTH TO ENDURE AND THE CHARACTER TO WEAR WELL—
OUR BUMPERS ARE READY FOR IT.



HEAVY-DUTY LOOKS
REAL CAPABILITY—WITH
A DURABLE FIT AND FINISH
YOU'LL JUST HAVE TO
AGE YOURSELF

BETTER CORROSION PROTECTION
Can-Am bumpers are E-Coated for supreme corrosion protection inside and out.



BUILT FOR BIG LIGHTS

Fully integrated bumper mounting plate gives rigid mounting and solid protection for multiple accessory lights.



100% INTEGRATED

Designed to seamlessly integrate with the style, fit, finish, and capability of your Traxter.



EXPERT CHOICE

FRONT BUMPER

- Heavy-duty 1.5" (3.8 cm) diameter steel-tube construction.
- Provides enhanced protection.
- Inside and outside anti-corrosion coating with durable powder coat finish.

Traxter, Traxter MAX (2019 & prior)
715002418



- Integrated mounting points for lights.
- Required to install the Xtreme Front Bumper Plates, Front Rack and the Front Corner Protectors.

Traxter, Traxter MAX (2020 & up)
715005754



XTREME FRONT BUMPER PLATES

- Made of high-strength heavy-gauge steel with rubber pads for increased protection.
- Inside and outside anti-corrosion coating with durable powder coat finish.
- Provide additional front-end protection.
- Not compliant with T-category vehicles.

Traxter, Traxter MAX (2019 & prior)
• Require Front Bumper (715002418) for installation.
715003005

Traxter, Traxter MAX (2020 & up)
• Require Front Bumper (715005754) for installation.
715005777



FRONT CORNER PROTECTORS

- Heavy-duty 1.25" (3.2 cm) diameter steel-tube construction.
- Provide enhanced protection for front corners.
- Inside and outside anti-corrosion coating with durable powder coat finish.
- Sold in pairs.

Traxter, Traxter MAX (2019 & prior)
• Require Front Bumper (715002418) for installation.
715002833

Traxter, Traxter MAX (2020 & up)
• Require Front Bumper (715005754) for installation.
715005774



715005774

Some products shown may not be available or homologated in your country. Contact your BRP dealer for local details.



RANCHER FRONT BUMPER

- The low front-end protection and plates allow you to use your vehicle within cattle herds and guard the safety of both the vehicle and the animals.
- The flat front portion facilitates gently prodding cattle or pushing light objects, e.g., closing a fence.
- The full frontage coverage extends to provide an extra layer of defense to your headlights and radiator.
- Inside and outside anti-corrosion coating with durable powder coat finish.
- Not compliant with T-category vehicles.

Traxter, Traxter MAX (2019 & prior)
715002834

Traxter, Traxter MAX (2020 & up)
• Improved approach angle.
• Compatible with front rack, snow plows, tire and track kits, winches.
715005410



715002834



715005410

XT FRONT BUMPER

- 1.5" (3.8 cm) diameter steel-tube construction.
- Provides light-duty protection.
- Inside and outside anti-corrosion coating with durable powder coat finish.
- Light-kit compatible.
- Standard on XT and XT Cab models 2018 and 2019.
- Not compatible with Xtreme Front Bumper Plates, Front Corner Protectors and LinQ Front Rack.

Traxter, Traxter MAX (2019 & prior)
715004407



XT-P FRONT BUMPER

- Heavy-duty 1.5" (3.8 cm) diameter steel-tube construction.
- Inside and outside anti-corrosion coating with durable finish.
- Provides additional front body protection.
- Integrated mount plate for auxiliary light installation.
- Winch Support Plate (705206371) is required for winch relocation at a higher position for easier access in muddy conditions (sold separately).
- Standard on XT-P models.

Traxter, Traxter MAX (2019 & prior)
■ 715004408 · Can-Am Red

Traxter, Traxter MAX
■ 715006145 · Silver



X MR FRONT BUMPER

- Heavy-duty 1.5" (3.8 cm) diameter steel-tube construction.
- Inside and outside anti-corrosion coating with durable finish.
- Provides additional front body protection.
- Integrated winch support plate for winch relocation at a higher position for easier access in muddy conditions or for auxiliary lights.
- Includes a front tow hook.
- Standard on X mr models.
- Winch sold separately.

Traxter, Traxter MAX (2019 & prior)
■ 715004405 · Black

■ 715004406 · Sunburst Yellow

Traxter, Traxter MAX (2020 & up)
■ 715006143 · Black

■ 715006144 · Green



CARGO BED PROTECTORS & TIE RAILS

- Heavy-duty 1.5" (3.8 cm) diameter steel-tube construction.
- Reliable cargo box protection and tie-down attachment point to secure large loads.
- Anti-corrosion coating with durable powder coat finish.
- Designed to stay in place when cargo bed side walls are removed.

Traxter PRO models
715005415

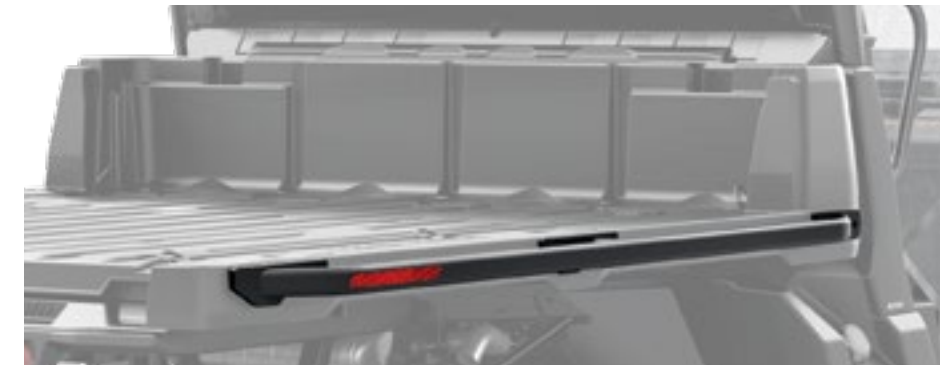

FRONT BODY SIDE PROTECTORS

- Heavy-duty 1.25" (3.2 cm) diameter steel-tube construction.
- Front side protection for farm, ranch and forestry applications.
- Offer complete front body protection.
- Inside and outside anti-corrosion coating with durable powder coat finish.
- Sold in pairs.

FRONT BODY SIDE PROTECTORS

- Require Front Bumper (715002418 or 715005754) with Front Corner Protectors (715002833 or 715005774) and Rock Slider (715002569 or 715003040 for MAX models) for installation.

Traxter, Traxter MAX
715003450

FRONT RANCHER BODY SIDE PROTECTORS

- Require Rancher Bumper (715002834/715005410) and Rock Sliders (715002569 or 715003040 for MAX models) for installation.

Traxter, Traxter MAX
715003617

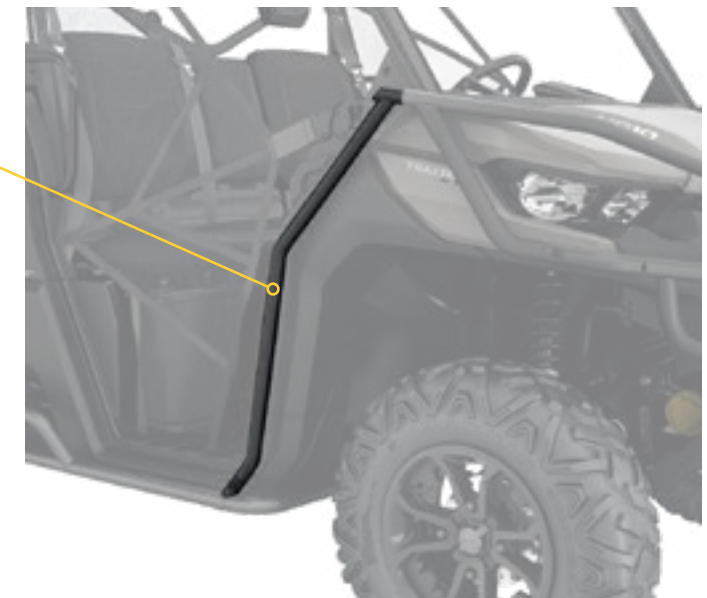

REAR BUMPER

- Heavy-duty 1.5" (3.8 cm) diameter steel construction and integrated tubular design.
- Increased protection of rear box and lower box corner while allowing normal tailgate function.
- Anti-corrosion coating with durable powder coat finish.
- Required to install Rear Body Side Protector (715003055).
- Rear bumper Adapter (715006060) is required for installation on the Traxter PRO models.

Traxter, Traxter MAX
715006012



REAR BUMPER ADAPTER

(Not illustrated)
• Required to install the Rear Bumper on Traxter models with the long box.

Traxter PRO models
715006060

REAR BODY SIDE PROTECTORS

- Heavy-duty 1.5" (3.8 cm) diameter steel-tube construction.
- Reliable cargo box protection.
- Inside and outside anti-corrosion coating with durable powder coat finish.
- Compatible with fender flares.
- Integrated brush and low-lying branch deflector.
- Require Rear Bumper (715006012 or 715002419) for installation.
- Sold in pairs.

Traxter, Traxter MAX (except PRO)
715003055





AGGRESSIVELY PROFILED TO KEEP MUD, DEBRIS, AND SNOW OUTSIDE THE VEHICLE.



FENDER FLARES

- Robust injection-molded polypropylene construction.
- Perfect for keeping mud and debris outside the vehicle.
- Include front and rear extension, and all mounting hardware.
- Ideal for track equipped vehicles.

Traxter (except PRO) **Traxter PRO**
715006821 **715006001**

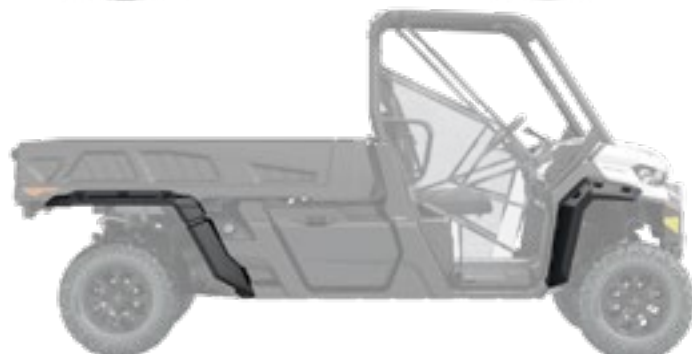

SPORT FENDER FLARES

- Sleek fender flares just the right size to reduce mud and debris kick-up from your tires.
- Robust injection-molded polypropylene construction.
- Include front and rear extension, and all mounting hardware.

Traxter (except PRO), Traxter MAX
715003898

ROCK SLIDERS

- Heavy-duty rock sliders made of painted 3/16" (5 mm) aluminum with an integrated step for elevated cargo box access.
- Protect vehicle's sides and undercarriage against large obstacles.
- Lodge tight up against vehicle body for better clearance from obstacles.
- Not compatible with other rock sliders.
- Sold in pairs.
- Standard on Traxter X mr, Traxter MAX X mr and Traxter XT-P models.

Traxter (2019 & prior) **Traxter (2020 & up)**
 ■ 715004409 · Black ■ 715006675 · Manta Green
 ■ 715005020 · Black ■ 715006672 · Red
 ■ 715006674 · Silver
 ■ 715006673 · Yellow

Traxter MAX (2019 & prior)
 ■ 715005020 · Black

Traxter (2020 & up)
 ■ 715006671 · Black

Traxter MAX 2020 & Traxter PRO
 ■ 715006721 · Black



715006675

ROCK SLIDERS

- Protect vehicle's sides and undercarriage against large obstacles.
- Made of heavy-duty 1.5" (3.8 cm) diameter steel tubing.
- Inside and outside anti-corrosion coating with durable powder coat finish.
- Integrated step for easy cargo box access.
- Sold in pairs.

Traxter **Traxter MAX, Traxter PRO**
 ■ 715002569 · Black ■ 715003040 · Black



MUD FLAPS

- Keep mud and debris out of cargo area and protect trailer or vehicles behind you.
- Add aesthetic appeal to your vehicle.
- Made of EPDM rubber.
- Require Rear Bumper (715006012 or 715002419) for installation.
- Sold in pairs.

Traxter, Traxter MAX
715003041



WHEN IT COMES TO MUD-MASTERING ACCESSORIES, S3 HAS THE EDGE IN DELIVERING PERFECT-FIT WINCH-READY BUMPERS FOR WORK, PLAY, AND RECOVERY.



Closed course dedicated for mud riding.

S3 FRONT WINCH BUMPER

- Made of 1.5" (3.8 cm) diameter steel tubing with durable powder coat finish.
- Specifically developed for mud riding enthusiasts.
- Integrated mounting plates accommodate all winches.
- Allows higher winch position to avoid winch immersion in mud.
- Added body protection.
- Not compatible with LinQ Front Rack, Removable Winch Mounting Kit, Super-Duty Plow Push Frame Extension and Plow Pulley.
- "S3 for Can-Am" branded.
- Winch not included.
- Not compliant with T-category vehicles.

Traxter, Traxter MAX (2019 & prior)

- 715003779 • Black
- 715005092 • Sunburst Yellow



S3 REAR WINCH BUMPER

- Made of 1.5" (3.8 cm) diameter steel tubing with durable powder coat finish.
- Specifically developed for mud riding enthusiasts.
- Integrated mounting plates for winches and towing anchor points.
- Added body protection.
- Not compatible with Apache 360 LT Track System and Removable Winch Mounting Kit.
- Compatible with Traxter winches (Rear Winch Electrical Harness required).
- "S3 for Can-Am" branded.

Traxter, Traxter MAX (2019 & prior)

- 715003782 • Black
- 715005123 • Sunburst Yellow



REAR WINCH ELECTRICAL HARNESS

- (Not illustrated)
- Required for the installation of a winch on the S3 Rear Winch Bumper.
 - Compatible with complete Traxter winch lineup.

Traxter, Traxter MAX (2019 & prior)
715004233

S3 NERF BARS

- Made of 1.5" (3.8 cm) diameter steel tubing with durable powder coat finish.
- Specifically developed for mud riding enthusiasts.
- Protect vehicle's lower sides without affecting ground clearance.
- Integrated step makes ingress easier.
- Not compatible with Front Body Side Protectors, Front Rancher Body Side Protectors and Apache 360 LT Track System.
- "S3 for Can-Am" branded.

Traxter

- 715003783 • Black
- 715005094 • Sunburst Yellow

Traxter MAX, Traxter PRO

- 715004349 • Black
- 715005124 • Sunburst Yellow



EASY ON, EASY OFF CARGO



A BRP EXCLUSIVE, LinQ IS A TOOL-LESS SYSTEM FOR NEAR-INSTANT INSTALLATION OF ACCESSORIES. QUICKLY, EASILY INSTALL AND REMOVE LinQ ACCESSORIES TO TRANSFORM YOUR MACHINE TO FIT THE MOMENT.

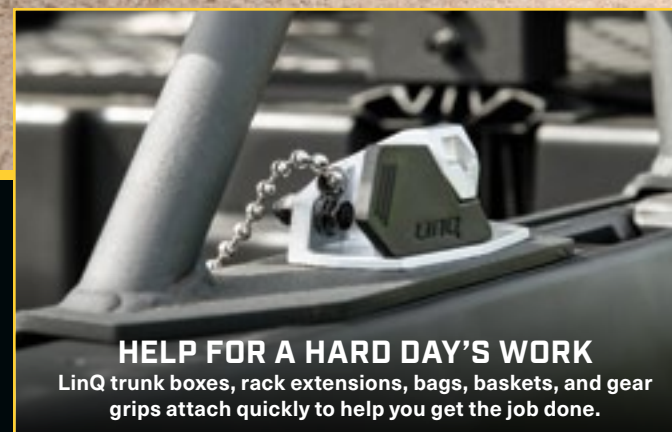

HELP FOR A HARD DAY'S WORK

LinQ trunk boxes, rack extensions, bags, baskets, and gear grips attach quickly to help you get the job done.

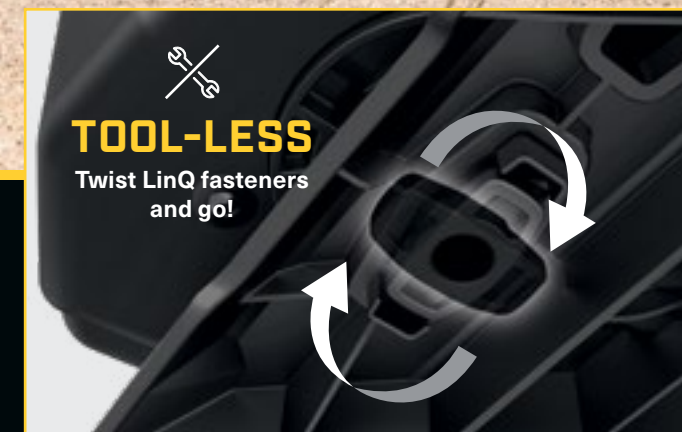

TOOL-LESS

Twist LinQ fasteners and go!

LinQ ACCESSORY TYPES

- LinQ with 16" base accessories are mounted with LinQ anchors 16 inches apart, ideal for Can-Am ATVs and SSVs, Sea-Doo watercraft, and Ski-Doo snowmobiles.
- LinQ with 36" base accessories are most commonly used as part of LinQ racks for Can-Am Off-Road vehicles.

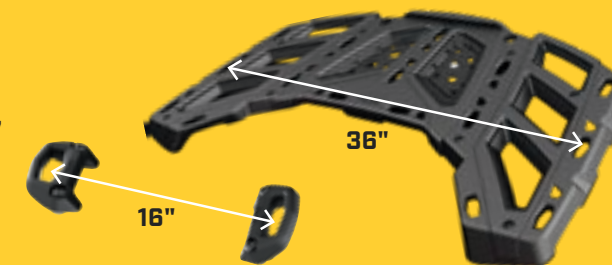

LinQ SYSTEM™ ACCESSORIES





- No tools needed: Quickly install and remove accessories by hand
- Equip your Can-Am for specialized tasks in no time
- Sturdy mounting system that holds up to the roughest terrain

MOUNTING LOCATION AND REQUIREMENTS

CARGO BED (long box bed LinQ) 	LinQ CARGO RACK 715006140 	ADVENTURE ROOF RACK 715003870 / 715004391 
--	--	--







- LinQ anchors mounted 16 inches apart, center-to-center.
- Lower loading capacity than the LinQ with 36" base accessories.
- Can be used on Can-Am ATV and SSV vehicles, Sea-Doo watercraft and Ski-Doo snowmobiles.

LinQ ACCESSORIES WITH 16" BASE p. 35

 LinQ 4.2 GAL (16 L) COOLER 295100698	LinQ Cargo Base Kit 860201806 + LinQ Base Installation Kit 860201812	LinQ Cargo Base Kit 860201806	Not compatible
 LinQ TOOL BOX 715004301	LinQ Base Installation Kit 860201812	No further requirements	No further requirements
 LinQ SR 5.5 GAL (21 L) BAG 860201740			
 LinQ 4.5 GAL (17 L) SPORT BAG 860201678			
 LinQ DRY BAG 715002875			

LinQ ACCESSORIES WITH 36" BASE p. 36

- Mount on LinQ racks often used by Can-Am ORV vehicles.
- Higher loading capacity than the LinQ with 16" base accessories.
- Usage is limited to Can-Am ORV vehicles.

 LinQ 12 GAL (45L) CARGO BOX 715003879	Not compatible	No further requirements	No further requirements		
 LinQ 23 GAL (86L) TRUNK BOX 715004923					
 LinQ 11.5 GAL (43L) AUDIO CARGO BOX 715003018					
 LinQ 8 GAL (30L) COOLER BOX 715004778 • Black / 715004698 • Grey			No further requirements	Not compatible	
 LinQ PREMIUM STORAGE BAG BY DGIO 715002923 • Black / 715003248 • Camo					
 LinQ HEAVY-DUTY BASKET 715001215					No further requirements
 LinQ LOW PROFILE BASKET 715004282					

LinQ RACKS & HOLDERS p. 41

 LinQ TOOL HOLDER 715003059	No further requirements	No further requirements	Side wall installation: LinQ Adapters 715003058
---	-------------------------	-------------------------	--



EQUIP YOUR TRAXTER FOR ADDED CARGO CAPACITY.

LinQ Accessories with 16" base

EXPERT CHOICE

LinQ 4.2 GAL (16 L) COOLER

- LinQ-mounted weather-resistant 4.2 Gal (16 L) cooler.
- Rotomolded construction for exceptional rigidity and durability.
- Premium-quality foam insulation for optimal ice retention.
- Sea-doo: marinized LinQ for salt water uses.

See table for installation location and requirements.

Traxter, Traxter MAX
295100698



LinQ TOOL BOX

- High precision injected HDPE construction provides rigidity and durability.
- 5 Gal (19 L) maximum capacity.
- Weather-resistant, sealed and lockable cover.
- Sea-doo: marinized LinQ for salt water uses.

See table for installation location and requirements.

Traxter, Traxter MAX
715004301



LinQ SR 5.5 GAL (21 L) BAG

- Semi-rigid expandable bag.
- 5.5 Gal (21 L) capacity.
- LinQ Cargo Base Kit (860201806) included.

See table for installation location and requirements.

Traxter, Traxter MAX
860201740



LinQ 4.5 GAL (17 L) SPORT BAG

- 4.5 Gal (17 L) capacity.
- Rigid bottom, semi-rigid top.

See table for installation location and requirements.

Traxter, Traxter MAX
860201678



LinQ DRY BAG

- Fully waterproof roll-top dry bag will securely store and confine your equipment.
- LinQ mounted using heavy-duty rigid plastic base.
- High capacity storage solution (40L).
- Bottom foam liner for additional equipment protection.
- Integrated handle for easy transportation on/off the vehicle.
- LinQ Cargo Base Kit (860201806) included.
- Sea-doo: marinized LinQ for salt water uses.

See table for installation location and requirements.

Traxter, Traxter MAX
715002875



LinQ Accessories with 36" base 

LINQ 12 GAL (45 L) CARGO BOX

- Holds cargo safely and securely while riding.
- See table for installation location and requirements.

Traxter, Traxter MAX
715003879



LINQ 23 GAL (86 L) TRUNK BOX

- Lockable and weather-resistant.
 - Holds cargo safely and securely while riding.
- See table for installation location and requirements.

Traxter, Traxter MAX
715004923



LINQ 11.5 GAL (43 L) AUDIO CARGO BOX

- An affordable and quick solution for adding music and storage to your next ride. The rear installation does not use up any cab space and allows easy listening at an average speed.
- Mounts on/off easily to hold/carry cargo safely and securely.
- The Bluetooth enabled receiver and 6.5" (16.5 cm) speakers are smartly concealed and integrated in the cover.
- Automatic shut-off function protects your battery by turning the system off after 10 minutes of inactivity.
- Backlit control panel perfect for night riding.
- Water-resistant speakers.

See table for installation location and requirements.

Traxter, Traxter MAX
715003018



LINQ 8 GAL (30 L) COOLER BOX

- Installs without vehicle modification.
- Rotomolded construction provides exceptional rigidity and durability.
- Premium-quality foam insulation for optimal ice retention.
- Integrated, fully-removable compartment protects food.
- Robust rubber latches keep the cover tightly closed.
- Weather-resistant.
- Convenient drain plug.

See table for installation location and requirements.

Traxter, Traxter MAX
 715004698 - Grey
 715004778 - Black



LINQ PREMIUM STORAGE BAG BY OGIO

- 17.2 Gal (65 L) capacity semi-rigid cargo bag ideal for carrying anything you need on your vehicle.
- Buckle and elastic closure with a rubber seal that protects dust from entering the bag.
- 3-section lid for partial or full access to your bag.
- Inside separators for optimal bag organization.

See table for installation location and requirements.

Traxter, Traxter MAX
 715002923 - Black

715003248 - Mossy Oak Break-Up Country Camo



Inside separators for optimal bag organization

LINQ HEAVY-DUTY BASKET

- Made of high-strength, low-alloy steel.

See table for installation location and requirements.

Traxter, Traxter MAX
715001215



LINQ LOW PROFILE BASKET

- Low profile, open basket increases cargo space.
- Perfect for easy access to tools, rope, winch and plow accessories.
- Multiple bungee cord and tie-down anchor points.
- Made of impact-resistant injected polypropylene.

See table for installation location and requirements.

Traxter, Traxter MAX
715004282



EXPERT CHOICE

LINQ TAILGATE EXTENSION FOR LONG BOX

- Adds rear cargo capacity when the tailgate is open.
- Steel-tubing-system-style barrier mounts on top of the bed walls using the easy, tool-less LinQ System.
- Can be mounted to serve as cargo divider at different locations along the bed wall while preventing larger items from falling off the back.
- Stores neatly out of the way and offers additional cab area protection since it can be mounted upside down on the front bed wall as a mini headache rack.
- Inside and outside anti-corrosion coating with durable powder coat finish.

Traxter, Traxter MAX
(except PRO models)
715002464

Traxter PRO
715005412



Cargo divider



Headache rack



LINQ TIRE HOLDER

- Cargo box spare-tire holder.
- Heavy-duty steel construction.
- Inside and outside anti-corrosion coating with durable powder coat finish.
- Mounts on top of the bed walls using the easy, tool-less LinQ System.
- Compatible with Bed Wall Extender.
- Uses BRP standard wheel bolt pattern to mount tire (nuts included).
- Accommodates BRP tires up to 28" (wheel not included).
- Quickly allows installation in multiple positions thanks to the LinQ System.

Traxter (except PRO models), Traxter MAX
715003448





LinQ FRONT RACK

- Rugged looking front rack mounts on top of vehicle hood and provides additional storage.
- Heavy-duty 1.25" (3.2 cm) diameter steel-tube construction.
- Inside and outside anti-corrosion coating with durable powder coat finish.
- Flip-up configuration provides easy access to service area.
- Allows the installation of LinQ accessories (especially for use with LinQ Low Profile Basket [715004282]).
- Kit includes LinQ Base.
- Multiple bungee cord and tie-down anchor points.
- Requires Rancher Bumper (715002834/715005410) or Front Bumper (715002418 or 715005754) for installation.
- A great place to store tools while working in the field.

Traxter, Traxter MAX (2019 & prior)
715004312

Traxter, Traxter MAX (2020 & up)
715006064



Allows the installation of LinQ Low Profile Basket, see p. 36

EXPERT CHOICE

NEW LOADOUT RACK

Available in Fall 2020

- LinQ installed versatile Rack that create a second level of storage.
- Adjustable height that goes from mid cab height to roof line.
- Modular basket adapts to different cargo with folding front and rear panels.
- Multiple hooks holes to hang items both inside and outside the rack.
- Basket accommodates multiple LinQ positions
- Combine with cargo net to create a hanging storage net below the basket for additional space.
- 2 Racks can be installed on Traxter Pro.

Traxter, Traxter MAX
715005447



Adjust the height depending on your cargo.



LINQ CARGO RACK

- Strong, durable steel rack.
- Easy and tool-less installation thanks to the LinQ System.
- Allows the installation of LinQ accessories.
- 2 racks can be installed at the same time.
- Allows multi-level storage on cargo bed, accommodates 5 Gal (19L) bucket.
- Helps keep cargo securely in place.
- Multiple bungee cord and tie-down anchor points.
- Kit includes LinQ Base.
- Provides more usable space in the cargo box.
- Extends vehicle cargo options.

Traxter, Traxter MAX
715006140

LINQ CARGO BASE KIT

- Unique mounting fastener usable on any LinQ System accessory.
- Included: 2 LinQ Cargo bases and hardware.

Traxter, Traxter MAX
860201806



LINQ REPLACEMENT PART

- Unique mounting fastener usable on any LinQ System accessory.
- Tool-less installation and removal.
- Sold in pairs.

Traxter, Traxter MAX
715001707



LINQ BASE INSTALLATION KIT

- Required to install LinQ Cargo Base Kit on the cargo bed.

Traxter PRO
860201812



HANGING STORAGE BOX KIT

- Versatile rack designed to hold a standard storage box.
- Fully adjustable, the rack can be tailored to hold the crates in multiple positions: Headache rack position, inside the box along the sidewall, and outside the box along the side wall.
- Includes Can-Am branded storage box.
- Exterior Cargo Reinforcement Panel is recommended when used outside of bed wall.

Traxter, Traxter MAX
715005449 • Black



CAN-AM STORAGE BOX

- (Not illustrated)
- Conventional 13" x 13" plastic storage box with Can-Am branding.
- Perforated bottom allows water and debris to escape.

Traxter, Traxter MAX
708303237 • Black

EXTERIOR CARGO REINFORCEMENT PANEL

- (Not illustrated)
- Plate that attaches to the bed side to further support and protect bed wall when in outward position.
- Recommended use of the Hanging storage box and/or gun and tool holder when installed outside of the bed wall (except Traxter PRO).

715006198



PROTECTION
AND CAPABILITY
READY FOR THE
ROUGH STUFF.



EXPERT CHOICE

DELUXE HEADACHE RACK

- Protects cab components from cargo load.
- Increases box capacity when used in tandem with the Bed Wall Extender (715002421).
- Required to install the Bed Wall Extender (715002421).
- Compatible with gear rail.

Traxter, Traxter MAX
715002423



HEADACHE RACK

- Full rear roll cage coverage offers a heavy-duty steel protective line of defense between your head or cab's components and the load in your cargo bed.
- Compatible with gear rail.
- Rack's open design helps maintain a clear rear view.
- Not compatible with Bed Wall Extender.

Traxter, Traxter MAX
715003873



EXPERT CHOICE

BED WALL EXTENDER

- Increases box capacity.
- Quick and easy tool-less modularity.
- Easily removable rear door can be latched open.
- Variable full or half height settings.
- Foldable top panels come off in seconds.
- Requires Deluxe Headache Rack (715002423).

Traxter, Traxter MAX (except Traxter PRO)
715002421

Traxter PRO models
715005411



TOP PANELS
FOLD DOWN
INSTANTLY



RACKS & HOLDERS

LINQ ADAPTER

- Allows the installation of the LinQ Tool Holder to the Bed Wall Extender or the Deluxe Headache Rack.
- Sold in pack of 4.

Traxter, Traxter MAX
715003058

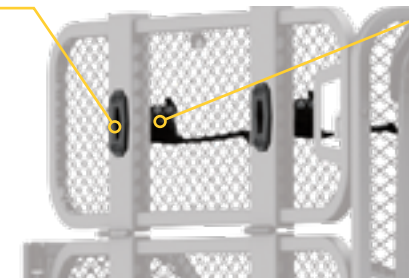

LINQ TOOL HOLDER

- Ultra-versatile tool holder.
- Convenient swivel-latch allows tools to be stored in any orientation.
- Suitable for installation onto the cargo walls, Deluxe Headache Rack, Adventure Roof Rack or Bed Wall Extender.
- If mounted on the Deluxe Headache Rack or the Bed Wall Extender, LinQ Adapter is required for installation.
- Sold in pairs.

Traxter, Traxter MAX
715003059



TONNEAU COVER

- Fitted to cover all of the items in your cargo box thoroughly.
- Prevents splash from entering the cargo box.
- Rolls up to the front.
- Easily removable for quick access.
- Not compatible with accessories that exceed the box height.

Traxter 2018 & up (except PRO, Mossy Oak Break-Up Country Camo model), Traxter MAX
715006011 • Black

Traxter, Traxter MAX (2017 & prior)
715003048 • Mossy Oak Break-Up Country Camo



REMOVABLE STORAGE BIN

- Handy, removable on-dash toolbox will make sure you have your critical equipment where you need it.
- Provides 1.7 Gal (6.3 L) of storage, and clips on and off in a snap.
- Water-resistant to ensure your contents remain safe and dry.
- Standard on all models except Base.

Traxter, Traxter MAX
715004344



DRIVER UNDERSEAT STORAGE BIN

- Polypropylene-injected 4 Gal (15 L) capacity bin fits securely under the driver's seat.
- Front opening for quick and easy access.
- Ideal for storing weather-resistant items, such as ropes, tow straps and winch accessories that are needed at a moment's notice.

Traxter, Traxter MAX
715003399



REMOVABLE STORAGE BIN - PASSENGER

- Convenient passenger-side underseat storage polypropylene-injected 3.7 Gal (14 L) storage capacity bin.
- Bin installs and removes in a snap and comes with an integrated handle.
- Water-resistant.

Traxter, Traxter MAX
715003314



CENTER UNDERSEAT STORAGE BIN

- Polypropylene-injected 2 Gal (8 L) capacity storage bin.
- Watertight design keeps ice and drinks cold.
- Easy to drain and wash by removing it with integrated handle.
- Accessible by lifting center seat section.

Traxter, Traxter MAX
715003446





CARGO BED RAILS

- Add integrated tie-down area to your cargo box while enhancing the look.
- Added cargo box protection.
- Inside and outside anti-corrosion coating with durable powder coat finish.
- Heavy-duty 1" (2.5 cm) diameter steel-tube construction.
- Add height to the bed side wall and serve as a tie-down anchor for ropes, straps or bungees.
- Not compatible with Bed Wall Extender.
- Sold in pairs.

Traxter (except PRO), Traxter MAX
715003444



CARGO BED NET

- Solid net designed to hook to the bottom of the cargo box for secure and compact confinement of your cargo.
- Keeps items tightly against the bed floor.

Traxter (except PRO), Traxter MAX
715003445



LOWER DASHBOARD FOR HEATING SYSTEM

- Replaces the dashboard that comes stock with the vehicle, and features a tablet that makes it possible for driver and passenger to conveniently store small items in the dash.
- To be installed when the Defrost, Heat & Ventilation System is installed.
- Use together with the Dash Storage Compartment Net for Heating System (715003544) to prevent the items placed in the dash storage compartment from falling.

Traxter, Traxter MAX (2019 & prior)
715003441



DASH STORAGE COMPARTMENT NET FOR HEATING SYSTEM

- Perfect for securing items in the dash storage area.
- To be installed when Lower Dashboard for Heating System is installed.

Traxter, Traxter MAX (2019 & prior)
715003544



DASH STORAGE COMPARTMENT NETS

- Perfect for securing items in the dash storage area.
- Not compatible with Defrost, Heat & Ventilation System.
- Sold in pairs.

Traxter, Traxter MAX (except Limited models)
715003129



BED TOOL BOX

- Large 40 Gal (150 L) multifunction weather-resistant tool box designed for cargo beds.
- Rotomolded construction provides exceptional rigidity and durability.
- Features cup holders and integrated groove for pipe or 2x4 cutting.
- Sized to give you the option of installing 2 tool boxes in the cargo bed (quick bolt-on installation).
- Double side openings with lockable covers and rubber latches.

Traxter, Traxter MAX
715003028



SOFT STORAGE BAG

- 11.8 Gal (45 L) capacity soft cargo bag designed with vehicle's rear in mind to maximize potential storage.
- 3 sections.
- Weatherproof.

Traxter, Traxter MAX
715003759 • Black



Vehicle shown is a Can-Am Outlander.

BACKREST REAR STORAGE

- Netting installs easily.
- Made from polyester that won't discolor.
- Sold in pairs.

Traxter MAX
715003019



STORAGE 2.6 GAL (10 L) BAG

- Roll-top dry bag for fully protecting your cargo from the elements.

Traxter, Traxter MAX
269502121



RACKS & HOLDERS



EXPERT CHOICE

NEW ACCESSORY BAR

- Strong accessory bar allowing installation or hanging items off the back.
- Holes for carabiners, duck decoy hangers or other items.
- LinQ anchors allow installation of many LinQ accessories.
- Pre-drilled holes for lights installation.

Traxter, Traxter MAX
715005450



ADVENTURE ROOF RACK

- Ideal cargo solution for packing everything you need to live your Off-Road experience fully and completely.
- Built with heavy-duty 1.25" (3.2 cm) diameter steel tubing.
- Modular LinQ support plates allow for installation of most LinQ cargo accessories.
- Integrated mounting points for lights can hold up to 8 pod-type LED lights (6 front and 2 back) or a 39" (99 cm) LED bar (front)—see table for compatibility.
- Features anchor points for spare tire attachment.
- Spare Tire Tie-Downs sold separately.
- Add the Cargo Box Net or the Cargo Box Elastic Net to secure and confine your cargo in the rack.
- Not compatible with Bimini Roof.

Traxter
Loads of up to 40 lb (18 kg).
715003870

Traxter MAX
Loads of up to 75 lb (34 kg).
715004391

BUILD YOUR OWN ADVENTURE ROOF RACK!

Shown here with:
SPARE TIRE WITH TIE-DOWNS
LinQ CARGO BOX, LinQ TOOL HOLDER
& 4" (10 CM) LED LIGHTS



SPARE TIRE RATCHET TIE-DOWNS

- 3-way ratcheting tie-down strap with loop ends.
- Designed to securely hold spare tires on accessories equipped with integrated spare tire attachment points.
- Adjustable to accommodate most common UTV tire sizes.
- Ratchet and junction ring made of durable zinc-plated steel.
- Required for spare tire attachment on Adventure Roof Rack.

Traxter, Traxter MAX
28000606



EXPERT CHOICE

LINQ TOOL & GUN HOLDER

- 2-in-1 holding rack can be used both on the job or on the hunt.
- Includes 5 locations to securely hold tools and guns using rubber grips and retention straps at the top and a rubber mat with gunstock shaped molding at the bottom.
- Easy to remove, install or reposition using our simple and secure LinQ System.
- Can be attached at multiple positions along the cargo bed walls, facing inside or outside the bed.
- Recommended to use with the Exterior Cargo Reinforcement Panel (715006198) when installed outside the bedwall.

Traxter, Traxter MAX
715005466



GUN BOOT MOUNT BY KOLPIN

- Fits one Kolpin Gun Boot 6.0 Impact.
- Lightweight and extremely durable.
- Easily adjustable without the use of any tools.
- Offers precision gun angle adjustability.
- Requires Gear Rail for installation.

Traxter, Traxter MAX
715001420



ADDITIONAL GUN BOOT MOUNT

(Not illustrated)
Traxter, Traxter MAX
715001586

GUN BOOT 6.0 IMPACT BY KOLPIN

- Extra room for pistol-grip-type weapons and small bipods.
- Easily fits firearms up to 51" (1.3 m) in total length.
- Provides ample room for 2.4" (60 mm) scopes.
- Hatchback design allows easy access.
- Snap-close cover with locking capability.
- Ergonomically designed handle and molded attachment points for sling.
- Designed to accommodate left- and right-hand bolt-action rifles and shotguns.
- Requires Gear Rail and Gun Boot Mount by Kolpin for installation.
- Includes removable, shock-absorbing foam and nylon Impact liner for superior interior protection.
- Compatible for dual mount with additional Gun Boot Mount.

Traxter, Traxter MAX
715001419



DUAL GUN HOLDER

- Accommodates shotguns, rifles or muzzleloaders.
- Mounts in the cab, on floor board between driver and passenger.
- Rubber pads provide gun protection.
- Can be removed to allow a center passenger.
- Anti-corrosion coating with durable powder coat finish.
- Comes with all hardware for easy installation.
- Keeps your weapons within easy reach and protected within the cab area.
- Refer to your local regulations governing the transportation of firearms before purchase.

Traxter, Traxter MAX
715005265

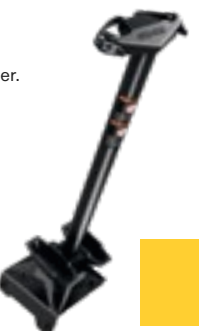



4-SEASON FIREARMS PROTECTION WITHIN REACH, WITH TOUGH & DURABLE GUN BOOTS FROM KOLPIN

STRONGHOLD GUN BOOT IMPACT⁺ BY KOLPIN⁺

- Compact low-profile design with Kolpin Stronghold styling securely holds up to 52" (132 cm) long rifles and shotguns with optics.
- Includes a removable, shock absorbing foam Impact⁺ liner.
- Single-handed opening with an attached lid for quick access along with an integrated closure strap.
- For use with the Kolpin Stronghold Auto-Latch Mount System.

Traxter, Traxter MAX
705011442

STRONGHOLD AUTO-LATCH MOUNT BY KOLPIN

- Auto-latching design provides quick and secure gun boot attachment to your vehicle.
- Bracket is made from rugged high-impact, reinforced nylon and coated steel.
- For use with Stronghold Gun Boot.
- Requires Gear Rail For Stronghold (715004089).

Traxter, Traxter MAX (except X mr models)
715003899

GEAR RAIL FOR STRONGHOLD

- Designed for the Stronghold Auto-Latch Mount by Kolpin.
- Can hold up to two Stronghold Gun Boots (two Latch Mounts required).
- Deluxe Headache Rack (715002423) or Gear Rail Adapter (715003392) required.

Traxter, Traxter MAX
715004089

GEAR RAIL

- Stationary rail system specially designed for your side-by-side vehicle.
- Universal mounting options for many Kolpin accessories like Gear Grips, Gun Boot 6.0, Gun Boot Mount and Universal Saw Press.
- Rail is made with heavy-duty 7-gauge extruded anodized black aluminum.
- Mounts on roll bar.
- Includes one versatile Gear Rail Mount by Kolpin.
- Requires Deluxe Headache Rack (715002423), Headache Rack (715003873) or Gear Rail Adapter (715003392).

Traxter, Traxter MAX (except X mr models)
715003391



GEAR RAIL ADAPTER

- Allows the installation of gear rails directly onto the cargo box without the need for a headache rack.

Traxter, Traxter MAX (except X mr models)
715003392



GEAR RAIL MOUNT BY KOLPIN

- Accessory bracket for mounting additional accessories to the Gear Rail.
- Includes C-clamp and metal mounting brackets.

Traxter, Traxter MAX
715001422



DOUBLE GUN BAG

- Shell constructed with heavy-duty, weather-resistant polyester to shelter guns from dust and other outdoor elements, while the thick interior padding protects the guns from shocks.
- Fits perfectly on rear cage, and guns are readily accessible from both sides of vehicle.
- Design features include a removable center pocket that can be mounted on both sides of the bag, and extra front storage pockets for hunting gear.
- Solid, quick installation.
- Not compatible with rear wind protection, headache racks and gear rails.
- May interfere with the tilt function of the Traxter PRO model's bed.

**Traxter (except XT Cab, X mr models),
Traxter MAX (except XT Cab and Limited package)**
■ 715003133 • Black

■ 715003134 • Mossy Oak Break-Up Country



STRENGTH FOR A PURPOSE: PERFECT-FIT HEAVY-DUTY GUN BAG KEEPS FIREARMS SECURE

UNIVERSAL SAW PRESS BY KOLPIN

- Specially crafted for transporting your chainsaw securely and safely aboard your side-by-side vehicle.
- Heavy-duty, black powder-coated metal bracket designed to attach any chainsaw model with up to a 20" (51 cm) bar.
- Rubber pads provide cushion and tight fit.
- Hinged design for quick removal.
- Holds saw in vertical position or 45° angle in either direction.
- Requires Gear Rail.
- Protective sheath included.

Traxter, Traxter MAX (except X mr models)
715001423

DURABLE MOUNT & HOLSTER KEEP YOUR CHAINSAW READY TO WORK



Vehicle shown is a Can-Am Commander.



GEAR GRIPS BY KOLPIN

- Durable, flexible grips cushion and protect while providing a custom fit for a variety of items from 1" to 4" (2.5 cm to 10 cm) in diameter.
- Heavy-duty design for carrying bows, fishing poles, rakes, farm tools and more.
- Quick-release button opens grip quickly for easy access to gear.
- Heavy-duty base system built for the toughest adventures.
- Easy installation on tubular racks, extension racks, brackets or bumpers.
- Sold in pairs.

Traxter, Traxter MAX
715001421



FUEL PACK BRACKET BY KOLPIN

- Easy, quick and secure bracket for your fuel pack that leaves plenty of room for your other gear.
- ¼-turn-action knob allows quick and easy removal of fuel pack from bracket.
- Not EC compliant to attach fuel packs.

Traxter, Traxter MAX
715001427



LIGHTS



39" (99 CM) DOUBLE STACKED LED LIGHT BAR (270W)

- Equipped with 54 5W Cree LEDs.
- 24,300 lumens.
- Not compatible with Full Windshield, Flip Windshield and Can-Am Intrusion Bar.
- Lights up to more than 2900 ft (900 m) in front of the vehicle and around 115 ft (35 m) wide on each side.
- Not EC compliant.

See table for installation location and requirements.

Adventure Roof Rack, Adventure Roof Rack MAX
715004007



15" (38 CM) DOUBLE STACKED LED LIGHT BAR (90 WATTS)

- Equipped with 18 5W Cree LEDs.
- 8,400 lumens.
- Rugged and waterproof.
- Not EC compliant.

See table for installation location and requirements.

Traxter, Traxter MAX
715002934



10" (25 CM) DOUBLE STACKED LED LIGHT BAR (60 WATTS)

- Equipped with 12 5W Cree LEDs.
- 5,400 lumens.
- Rugged and waterproof.
- Packs a big punch for its size.
- Not EC compliant.

See table for installation location and requirements.

Traxter, Traxter MAX
715002933



BUILD YOUR LIGHTING SYSTEM. Refer to page 50.

24,300 LUMENS

Lights up to more than 2900 ft (900 m) in front of the vehicle and around 115 ft (35 m) wide on each side.

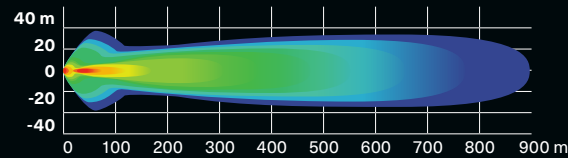

8,400 LUMENS

Lights up to more than 1900 ft (580 m) in front of the vehicle and around 65 ft (20 m) wide on each side.

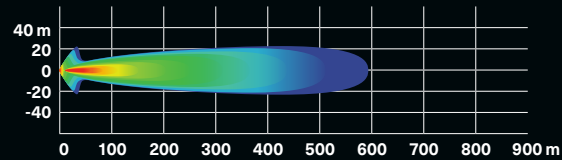

5,400 LUMENS

Lights up to more than 1500 ft (460 m) in front of the vehicle and around 65 ft (20 m) wide on each side.

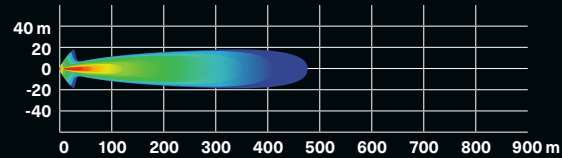

4" (10 CM) ROUND LED LIGHTS (2 X 25 WATTS)

- 25W LED spotlights.
- 1,800 lumens.
- Rugged and waterproof.
- Includes basic wiring and switch.
- Can-Am branded grill.
- Sold in pairs.
- Not EC compliant.

See table for installation location and requirements.

Traxter, Traxter MAX
715002935



3.5" (9 CM) LED LIGHTS (2 X 14W)

- 14W LED lights producing 1,260 lumens each.
- Equipped with 6 high power LEDs in a heavy-duty die cast aluminum housing.
- Features 2 attachment points — if one attachment point fails due to a collision, rotate to the next channel point and re-mount the light.
- Sold in pairs.
- CE certified.

See table for installation location and requirements.

Traxter, Traxter MAX

LED DRIVING LIGHTS

- Spot lens for a narrow and long light beam spread, ideal when driving at higher speeds.

715003666

LED FLOOD LIGHTS

- Flood lens for a wide light beam spread, ideal for working applications like plowing or for cornering, dusty or foggy riding conditions.

715003665



1,800 LUMENS

Perfect fit with the Light Rack and most bumpers.

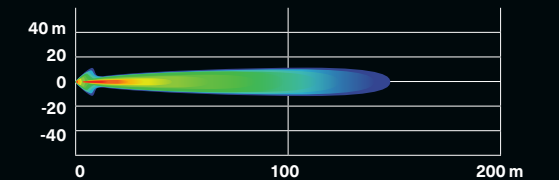

1,260 LUMENS

LED Driving Lights

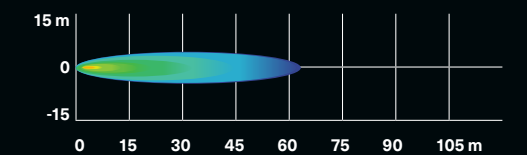

LED Flood Lights

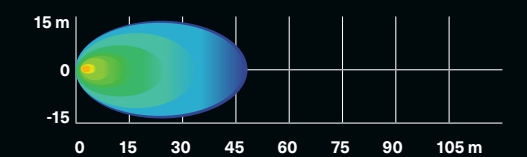



BUILD YOUR LIGHTING SYSTEM IN 4 EASY STEPS

		1 CHOOSE YOUR MOUNT POINT	2 CHOOSE YOUR LIGHTS				
			10" (25 Cm) Double Stacked LED Bar	15" (38 cm) Double Stacked LED Bar	39" (99 cm) Double Stacked LED Bar	4" (10 cm) Round LED LIGHTS (Sold in pairs)	3.5" (9 cm) LED Lights (Sold in pairs)
3 FIND YOUR PLATFORM	TRAXTER, TRAXTER MAX 2019 & PRIOR	Front Bumper Rancher Bumper XT Front Bumper	715002933 PLUS 715002454 (Light Power Cable)	715002934 PLUS 715002454 (Light Power Cable)	N/A	715002935 (4" Round), 715003665 (3.5" Flood) or 715003666 (3.5" Spot) PLUS 715002454 (Light Power Cable)	
	TRAXTER, TRAXTER MAX 2020 & UP	X mr Front Bumper (w/o winch) X-TP Front Bumper	715002933 PLUS 715006034 (Light Power Cable)	715002934 PLUS 715006034 (Light Power Cable)	N/A	715002935 (4" Round), 715003665 (3.5" Flood) or 715003666 (3.5" Spot) PLUS 715006034 (Light Power Cable)	
	TRAXTER, TRAXTER MAX 2019 & PRIOR	Lone Star Edition Front Bumper	715002933 PLUS 715002454 (Light Power Cable)	N/A	N/A	N/A	
	TRAXTER, TRAXTER MAX 2020 & UP		715002933 PLUS 715006034 (Light Power Cable)	N/A	N/A	N/A	
	TRAXTER & TRAXTER MAX (EXCEPT XT CAB)	Light Rack *Roof Power Cable and Front Roof Liner may not be required if already installed with other accessories.	715002933 PLUS 715003094 (Roof Power Cable) & 715003098 (Front Roof Liner)	715002934 PLUS 715003094 (Roof Power Cable) & 715003098 (Front Roof Liner)	N/A	715002935 (4" Round), 715003665 (3.5" Flood) or 715003666 (3.5" Spot) PLUS 715003094 (Roof Power Cable) & 715003098 (Front Roof Liner)	
	TRAXTER, TRAXTER MAX XT CAB LIMITED		715002933	715002934	N/A	715002935 (4" Round), 715003665 (3.5" Flood) or 715003666 (3.5" Spot)	
	TRAXTER & TRAXTER MAX (EXCEPT XT CAB LIMITED)	Adventure Roof Rack *Roof Power Cable may not be required if already installed with other accessories.	N/A	Front only: 715002934 PLUS 715003417 (Power Cable) & 715003094 (Roof Power Cable) & 715003098 (Front Roof Liner)	Front only: 715004007 PLUS 715005822 (Power Cable) & 715003094 (Roof Power Cable) & 715003098 (Front Roof Liner)	Front or Rear: 715002935 (4" Round), 715003665 (3.5" Flood) or 715003666 (3.5" Spot) PLUS 715003417 (Power Cable) & 715003094 (Roof Power Cable) & 715003098 (Front Roof Liner)	
	TRAXTER, TRAXTER MAX XT CAB LIMITED		N/A	Front only: 715002934 PLUS 715003417 (Power Cable)	Front only: 715004007 PLUS 715005822 (Power Cable)	Front or Rear: 715002935 (4" Round), 715003665 (3.5" Flood) or 715003666 (3.5" Spot) PLUS 715003417 (Power Cable)	

4 ORDER

ORDER ALL PART NUMBERS IN INTERSECTING BOX

*NOTE: When installing more than one light kit, additional Light Power Cable or Mounting Kit is required.



PERFECT MOUNT SOLUTION FOR THE LIGHTS OF YOUR CHOICE.



4" (10 CM) ROUND LED LIGHTS



15" (38 CM) DOUBLE STACKED LED LIGHT BAR

LIGHT RACK

- Rugged steel construction serves as both mount and protection for accessory light systems.
- Lights not included.
- Front Roof Liner is required for installation on the roof (except Cab models or with Deluxe Sport Roof [715002511]).
- Power Cable (715003094), Sport Roof (715002430), Bimini Roof with Sun Visor (715002849), Deluxe Sport Roof (715002511) or Sport Roof for MAX (715003038) required for installation.
- Integrates elegantly and seamlessly into our roof products.

Traxter, Traxter MAX
715002456



REAR CARGO LIGHT

- Powerful 55W H3 illumination for rear cargo area.
- Convenient in-dash switch.
- Wiring included.
- Sport Roof (715002430), Deluxe Sport Roof (715002511) or Sport Roof for MAX (715003038) is required for installation.
- Not EC compliant.
- Not compatible with headache rack on Traxter PRO.

Traxter, Traxter MAX (2020 & up)
715007077



RAM+ LED SPOTLIGHT

- 540 lumens LED light (9 Watt) heavy-duty spotlight standard-equipped with 1" (2.5 cm) diameter rubber-coated double ball and socket system.
- Not EC compliant.

Traxter, Traxter MAX (2019 & prior)
710005423



DOME LIGHT

- LED array integrates perfectly with vehicle.
- Wiring included.
- Can be installed on cage or roof, with or without roof liner.

Traxter, Traxter MAX
715002455



LED SIGNATURE LIGHTS

- The stylish LED set puts the finishing touch to your Traxter, accentuating its aggressive stance.
- Included on Limited and Lonestar models.
- Not EC compliant.

Traxter, Traxter MAX (2020 & up)
715006896



ROOF POWER CABLE

- (Not illustrated)
- Brings power from the battery.
- Required for installation of some electrical accessories.

Traxter, Traxter MAX
715003094

LIGHT KIT POWER CABLE

- (Not illustrated)
- Power cable for installation of compatible Can-Am light kits at front bumper location.

Traxter, Traxter MAX (2019 & prior)
715002454

Traxter, Traxter MAX (2020 & up)
715006034

AUDIO & COMMUNICATION SYSTEMS

STAY ENTERTAINED ON JOBSITES AND LONG RIDES WITH COMPLETE BLUETOOTH MUSIC INTEGRATION.



BRING YOUR FAVORITE MUSIC WHEREVER YOU ROAM.



RUGGED. WATERPROOF. POWERFUL.

Add up to 4 ultra-sturdy outdoor speakers, designed to be Can-Am tough. Our Overhead Audio System will rock with high-fidelity sound... everywhere.

⚡ STAY CONNECTED

Our Rugged Radios Car-to-Car System is perfect for communicating with friends and family on group rides.

EXPERT CHOICE

OVERHEAD AUDIO SYSTEM

- Rugged waterproof Jensen® Bluetooth Stereo Audio System offers multi-source input: AM/FM/WB and USB (iPod® and iPhone® ready).
- Convenient white LED-backlit LCD display and buttons.
- Stream from any Bluetooth-enabled device (smartphone, MP3 player).
- Powerful 4x40W amplifier with remote turn-on.
- Voice-control of AVRCP-active device.
- 30 programmable AM/FM stations with auto-store/pre-set scan.
- Separate RCA audio output and input.
- UV-resistant finish / corrosion-resistant components.
- Requires Sport Roof (715002430), Front Roof Liner (715003098) or Deluxe Sport Roof (715002511) and Power Cable (715003094).



COMPLETE OVERHEAD AUDIO SYSTEM

- Complete with 4 ultra-sturdy outdoor speakers (2 front and 2 rear) and 4 black speaker boxes.

Traxter, Traxter MAX
715002019

OVERHEAD FRONT AUDIO SYSTEM

- Complete with 2 ultra-sturdy front outdoor speakers and black speaker box.

Traxter, Traxter MAX
715003095

RUGGED RADIOS CAR-TO-CAR SYSTEM

- Perfect for communicating with friends and family on group rides.
- Push-to-talk button conveniently mounted on the steering wheel.
- Includes radio mounting bracket, helmet speaker, mic kit and base charger.
- May be synched with the Rugged Radios Intercom System (715002891).
- 2-4 mile range.

This kit includes:

- RH-5R Rugged Radios 5-Watt Dual Band Handheld Radio
- Helmet Speaker/Mic Kit
- Push-to-talk buttons
- Mounting bracket
- Base station charger

Traxter, Traxter MAX
715003440



RUGGED RADIOS INTERCOM SYSTEM

- Specifically designed to facilitate clear in-vehicle communication between driver and passenger(s).
- Expandable to 4 people.
- Includes music port for enjoying your favorite tunes.
- Seamless integration with in-dash switch panel.
- May be synched with the Rugged Radios Car-To-Car System (715003440).

Traxter, Traxter MAX
715002891



EXPERT CHOICE

REAR VIEW MIRROR & CAMERA MONITOR

- Fully waterproof rearview camera and monitor kit.
- Multiple camera feeds can be seen with the rearview camera, to see what you need.
- Unit replaces stock rearview mirror (screen is integrated in the unit's replacement rearview mirror).
- Camera uses infrared light for night vision capabilities.

Traxter, Traxter MAX
715004905 Black



BACK-UP MONITOR AND CAMERA KIT

- Fully waterproof rearview camera and monitor kit.
- The camera is one of the clearest and sharpest available on the market, with 250,000 pixel image resolution and a 2.1 mm lens with 130° viewing angle.
- Features 18 infrared lights that allow up to 50 ft. (15.24 m) visibility in complete darkness, an auto iris sensor that adapts to light intensity changes and an adjustable sunshade.
- 7" (17.78 cm) digital TFT LCD color monitor comes with power harness and can support up to two camera inputs.
- The camera can be roof mounted to monitor your cargo load or to see farther behind, and it can be mounted under the cargo box for hitching purpose.
- Not compatible with Defrost Heat and Ventilation System or HVAC.

Traxter, Traxter MAX
715003834



EXPERT CHOICE

BATTERY CHARGER/MAINTAINER

- Keeps stored lead-acid batteries charged.
- Charges and maintains small batteries.
- Microprocessor controlled multi-stage charging for added precision, safety and battery life.
- Reverse hook-up protection helps protect battery and charger from damage.
- Automatically detects 6- or 12-volt batteries.
- Press the display button to show the charge progress.
- Content: 3 amp battery charger, clamp adapter, DC adapter, 24" (61 cm) fused ring leads harness with weather cap, owner's manual.

715005061



DIGITALLY ENCODED SECURITY SYSTEM (D.E.S.S.™) KEYS

- Top-security anti-theft protection for your vehicle.
- Encrypted chip technology restricts access to your vehicle's electronic ignition system.
- One vehicle / One code.
- A vibration / shock-resistant ball-and-socket design that ensures a reliable connection.

Comes with 3 programmable keys:
• Work key: Limits vehicle speed to 40 kph (25 mph) but does not limit engine torque.
• Normal key: Limits vehicle speed to 70 kph (44 mph) and 10% torque reduction.
• Performance key: No restrictions.

Traxter, Traxter MAX
715002458



JUMP STARTER

- IPX3 water-resistant and enclosed output ports.
- 4 LED battery indicators for easy read on battery charge level.
- Compact design, will conveniently fit in your backpack, glove box or any other storage compartment.
- 2.4A + 1A/5V USB ports for fast charging of all USB devices.
- Smart cable provides protection against reverse polarity, short circuit, low voltage, high temperature and reverse charging.
- Built-in LED light (3 modes).
- Content: 300CA jump starter, SA858 smart cable clamp, MC-USB to USB charging cable, travel bag, user manual.

715005062



QUICK CONNECT BATTERY CABLE

- Quickly and easily connect and charge different items with your charger.
- Included in the Battery Charger/Maintainer.
- Sold individually.

715005408



QUICK CONNECT CABLE WITH BATTERY INDICATOR

- Quickly and easily connect and charge different batteries with your charger.
- 3-color LED indicator provides constant battery health indication.
- Sold individually.

715006055

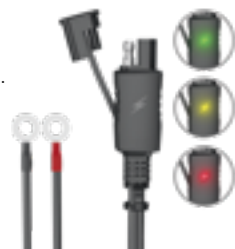

3-MODE SWITCH

- Switches quickly and conveniently between normal/work/eco modes.
- Work mode: Reduced throttle sensitivity for smoother acceleration and reduced load impact.
- Eco mode: Increased fuel economy.
- In-dash plug-and-play mount.
- Standard on 2020 models.

Traxter, Traxter MAX
715004445



EXPERT CHOICE

AUXILIARY BATTERY INSTALLATION KIT

- Allows you to add a second 30Ah battery for that dual battery setup that will give you the extra juice you'll need to power auxiliary electrical components like a sound system or winch.
- Additional battery sold separately (515176151).
- Equipped with an integrated smart battery isolator that will prevent your auxiliary electrical components from draining your starting battery.
- Kit includes an additional battery junction block, all necessary wiring and the battery holder.

Traxter, Traxter MAX (2019 & prior)
715003758

Traxter, Traxter MAX (2020 & up)
715006035



REAR 12V POWER OUTLET

- Kit brings power source to the cargo box area.
- Installs into the rear cab firewall.
- Easy plug-in harness included.

Traxter, Traxter MAX (2019 and prior)
715003846



USB POWER OUTLET KIT

- Recharges your electronic devices while riding* (smartphone, MP3, heating gear, etc.).
- Dual port USB connectors.
- *The power outlet is not capable of recharging all device types while riding.

Traxter, Traxter MAX (2020 & up)
219400510



GARMIN MONTANA+ 680T GPS

- Rugged and waterproof, the Montana 680T is element-proof.
- 4" dual-orientation, sunlight-readable touchscreen and glove-friendly touchscreen display to give you vivid colors and high-resolution images.
- 8-megapixel autofocus camera automatically geotags photos.
- Tracks both GPS and GLONASS satellites for improved positioning and typically faster fixes.
- Preloaded TOPO maps, plus 1-year BirdsEye Satellite Imagery subscription.
- 3-axis compass with barometric altimeter.
- Specific GPS cradle included (vehicle mounting kit required).
- Includes a preloaded map for US.

Traxter, Traxter MAX
715002830

European Version
• EC compliant.
• Includes preloaded European recreation map.
715003456



RAM GPS MOUNT

- Allows for GPS integration onto vehicle.
- Standard AMPS hole pattern for Garmin Cradle.

Traxter, Traxter MAX
715003325



CTEK BRP 5.0 BATTERY CHARGER

- CTEK, the manufacturer of the smartest battery chargers in the world, has produced a BRP specific charger for all BRP products.
- CTEK Charger is built to meet the demanding arctic conditions.
- Ask your dealer for more information.

860200997



DEFROST, HEAT & VENTILATION SYSTEM

- Best integrated system on the market with 3-ventilation speed and in-dash adjustable temperature.
- Adjustable/directional vents.
- 10 vents specially positioned for better windshield and side windows defrosting/deicing, foot and hand heat.
- Easy-service air filter.
- Once installed, you might want to add storage space with the Lower Dashboard for Heating System and Dash Storage Compartment Net for Heating System.

Traxter, Traxter MAX 2019 & prior (not compatible with HD5 Motorization)
715004917

- Best integrated in-dash system on the market with 3 fan speeds and adjustable temperature.
- Adjustable/directional vents can be closed to concentrate heat at specific areas.
- A total of 8 vents specially positioned for windshield and occupant heating.
- Easy-to-service air filter.
- Includes the replacement lower dashboard compartment for the heating system.
- Dash Storage Compartment Net for Heating System is recommended.

Traxter, Traxter MAX (except Traxter PRO models) 2020 (not compatible with HD5 motorisation)
715005904

Traxter, Traxter MAX 2021 (not compatible with HD5 motorisation)
715007353



EXPERT CHOICE

HEATED STEERING WHEEL

- Ruggedly constructed steering wheel designed to withstand cold conditions while channeling heat directly to your hands.
- Perfect for making hand mobility and grip readily available, e.g., hunting, manual farming.
- Replaces stock steering wheel.
- This kit includes the heated steering wheel and in-dash switch.
- Draws a maximum of 45W and 3.2A at 13.5V.
- Heated Accessories Wiring Harness (710005757) is required on all models except XT Cab 2020 & up, which requires Heated Accessories Wiring Harness (710006036).
- Not EC compliant.

Traxter, Traxter MAX
715003837



RADIATOR WINTER FRONT

Allows you to get higher heating temperature out of the Defrost, Heat & Ventilation System in extremely cold conditions.

Traxter (2019 & prior)
715005108



HEATED VISOR OUTLET

- Strategically positioned on vehicle to maintain your agility.
- Optional visor outlet that delivers fog-free riding.
- Quick and easy installation.
- Sold individually.
- Heated Visor not included.

Traxter, Traxter MAX
715001246



HEATED GRAB BAR COVER

- Made tough to hold up to the stresses of rough riding, this heated cover will keep your passenger's hands warm and securely gripped during long cold outings.
- Easy to install and remove.
- This kit includes the heated grab bar cover and in-dash switch.
- Heated Accessories Wiring Harness (710005757) is required on all models except XT Cab 2020 & up, which requires Heated Accessories Wiring Harness (710006036).

Traxter, Traxter MAX
715003835



HEATED SEAT

- 25W seat heater delivers chill-free riding comfort.
- Hi/Low temperature settings allow you to control the desired degree of warmth.
- This kit includes one carbon fiber seat heater, foam sheet and in-dash switch.
- Installs directly in the original seat cushion.
- Heated Accessories Wiring Harness (710005757) is required for installation on front seat.
- Heated Accessories Wiring Harness (715006036) is required for installation on Traxter XT Cab and Limited models.
- Heated Accessories Wiring Harness (715006004) is required for installation on rear seats on MAX models.

Traxter, Traxter MAX
715006112



HEATED SEAT HARNESS FOR MAX MODEL

- (Not illustrated)
- Electric harness required to hook up and operate rear heated seats.

Traxter MAX
715006004

HEATED ACCESSORIES WIRING HARNESS

- (Not illustrated)
- Electric harness required to hook up and operate heated accessories.
- Power up to 4 accessories: 2 hand accessories (grab bar/steering wheel) and 2 seat covers.

Traxter, Traxter MAX (2020 XT CAB & Limited models)
715006036

Traxter, Traxter MAX (except 2020 XT CAB & Limited models)
710005757

WINCHES & HITCHES

WARN[†] VRX

- Extreme IP68-rated waterproof sealing keeps the elements out.
- Durable all-metal construction.
- Black powder-coated finish and stainless steel fasteners for corrosion resistance.
- Robust clutch design based on 70+ years of WARN 4WD hub lock know-how.
- Load-holding brake for great control.
- Smooth and reliable all-metal three-stage planetary gear train.
- Dash-mounted rocker control and corded remote.
- Limited lifetime warranty (mechanical), 3-year warranty (electrical).
- Pulling strength capability of 4,500 lb (2,041 kg).
- Winch electrical harness (715006032) is required for installation.

WARN VRX 45 WINCH

- 50 ft. of ¼" (15 m of 6.3 mm) wire steel cable.
- Roller fairlead.

Traxter, Traxter MAX
715006110



WARN VRX 45-S WINCH

- 50 ft. of ¼" (15 m of 6.3 mm) synthetic rope.
- Cast aluminum fairlead.

Traxter, Traxter MAX
715006111



CAN-AM HD

- Ergonomic clutch handle.
- Rugged all-steel gears and bushings for more torque and durability.
- Automatic 100% load-holding brake.
- Sealed solenoid for all-weather protection.
- Weather sealed corded remote and dash mounted switch.
- EC compliant.

CAN-AM HD 4500 WINCH

- Pulling strength capability of 4,500 lb (2,041 kg).
- 43 ft. of ¼" (13.1 m of 6.3 mm) wire steel cable.
- Heavy-duty 4-way roller fairlead.
- Winch Electrical Harness (715007078) is required for installation on Base and DPS models.

Traxter, Traxter MAX
715006416



CAN-AM HD 4500-S WINCH

- Pulling strength capability of 4,500 lb (2,041 kg).
- 50 ft. of ¼" (15.2 m of 6.35 mm) synthetic rope.
- Corrosion-proof aluminum hawse fairlead.
- Winch Electrical Harness (715007078) is required for installation on Base and DPS models.

Traxter, Traxter MAX
715006417





PULL HEAVY LOADS AND LARGE GAME INTO THE BED WITH EASE.

NEW CARGO BED WINCH

- Allows you to pull heavy loads into the cargo box easily.
- Perfect for hunting applications, i.e., loading game.
- Includes support base made of heavy-duty 2" (5 cm) steel tubing, winch and weather-sealed corded remote.
- 750 lb (340 kg) maximum pulling capacity.
- Electronic security module to prevent vehicle damage that could occur if loaded vehicle exceeds manufacturer's gross weight rating.
- Adapter Kit (715004709) required for installation with Gear Rail Adapter.
- Requires Powertilt bed for Traxter PRO.

Traxter, Traxter MAX
715006355

SYNTHETIC WINCH CABLE*

- 50' of ¼" (15.2 m of 6.35 mm) synthetic cable for Warn winch.
- Warn Hawse Fairlead is required when upgrading to a synthetic cable to avoid damage and premature wear of the cable.

With Warn winch
705015070

- 50' of ¼" (15.2 m of 6.35 mm) synthetic cable for Can-Am HD winches.
- Hawse Fairlead (715006426) required when upgrading to a synthetic cable to avoid premature cable damage and wear.

With Can-Am HD winch
715006430



SYNTHETIC CABLE EXTENSION

- Lightweight ¼" (6.35 mm) diameter, easy to handle and won't rattle in cargo box.
- Easily attaches to winch cable to provide additional 50' (15.2 m) of distance.
- 4,500 lb (2,041 kg) single line capacity.

715001120

REPLACEMENT WIRE ROPE*

- 55' of ¼" (16.8 m of 6.35 mm) wire rope for Warn winch kit.
- 4,500 lb (2,041 kg) pulling strength.

With Warn winch
715006699

- 43' of ¼" (13.1 m of 6.3 mm) wire rope.
- 4,500 lb (2,041 kg) pulling strength.

With Can-Am HD winch
705014978



WARN HAWSE FAIRLEAD*

- Double-powder-coated construction.
- Required to use the Synthetic Winch Cable (705015070) on Warn winches.
- To be used with synthetic winch cables only.

With Warn winch
705208797



CAN-AM HD HAWSE FAIRLEAD

- A must when upgrading your winch with a synthetic cable, this corrosion-proof aluminum hawse fairlead will prevent the cable from snapping in a corner of a roller fairlead and from wearing prematurely due to the rough surface of the worn roller guide.
- Must be used with synthetic cables only.

With Can-Am HD winch
715006426



ROLLER FAIRLEAD

- Suggested when changing the wire rope.
- Heavy-duty replacement fairlead for winches.

With Can-Am HD winch
710007082



WIRED REMOTE CONTROL

- This kit allows winch owners to add the hand-held remote to vehicles with a stock winch.
- Works in conjunction with the mini-rocker switch.
- Remote control (710007050) and connection socket are included with Can-Am HD winch.
- EC compliant.

With Can-Am HD winch **With Warn winch**
715006504 710001002



WIRELESS REMOTE CONTROL

- The system is quick and easy to install, thanks to a wiring harness with an integrated antenna and all necessary mounting hardware.
- Allows you to operate your winch from anywhere within a 50' (15.2 m) radius, increasing your recovery options.
- All components are weatherproof.

With Warn winch (Traxter 2019 & prior)
715002542



DROP TOW BAR

- Sturdy 2" (5 cm) ball-less tow bar.
- Conveniently set at standard trailering height.
- Requires Higher Front Receiver Hitch (715003109).

Traxter, Traxter MAX
715002521



WINCH ELECTRICAL HARNESS

- (Not illustrated)
- Required to install a winch on a Traxter without a factory-installed winch.

Traxter, Traxter MAX (2019 & prior)
715003093

Traxter, Traxter MAX (2020 & up)
715007078

MULTIMOUNT WINCH HARNESS

- (Not illustrated)
- Converts Removable Winch Mounting Kit into a practical multimount winch kit.

Traxter
710004869

Traxter MAX
710005082

REMOVABLE WINCH MOUNTING KIT

- Allows you to remove your winch when needed.
- Use in combination with the Multimount Winch Harness to quickly and conveniently relocate a front-mounted winch to the rear of the vehicle.
- Not compatible for use with the Lower Front Receiver Hitch.
- Requires Higher Front Receiver Hitch (715003109).

Traxter, Traxter MAX (except Limited models)
715001652



LOWER FRONT RECEIVER HITCH

- Heavy-duty 1,500 lb (680 kg) towing capacity 2" (5 cm) receiver hitch.
- Expand and enhance functionality by pairing it with Higher Front Receiver Hitch and Removable Winch Mounting Kit (need to relocate winch from its standard mounting position).

Traxter, Traxter MAX
715002519



HIGHER FRONT RECEIVER HITCH

- Heavy-duty 1,500 lb (680 kg) towing capacity 2" (5 cm) receiver hitch.
- No need to relocate winch from its standard mounting position.

Traxter, Traxter MAX (except Limited models)
715003109



FRONT & REAR HITCH DRAWBAR

- Standard on 2" (5 cm) receiver hitch.
- It offers 1,500 lb (680 kg) of towing capacity.
- Hitch ball not included.

Traxter, Traxter MAX
715000972

European Version
• Drawbar with 2" (50 mm) hitch ball.
715001473
705206264 (T Homologated)



RUBBER RECEIVER PLUG

- Rubber cap for 2" (5 cm) Receiver Hitch.

705204503



SEATS

CENTRAL HEADREST

- Headrest for front-center-seating position on 3-seated models and for rear-center-seating position on MAX models.
- Front Headrests are available separately for front passengers on MAX models.
- Headrests are required for all passengers on some regulated trails.
- Not EC compliant.

Traxter, Traxter MAX
715005163



FRONT HEADRESTS

- Additional headrest for all three front-seating positions on MAX models.
- Central Headrest is available separately for rear-center-seating positions on MAX models.
- Headrests are required for all passengers on some regulated trails.
- Not EC compliant.

Traxter MAX
715005164



HEADRESTS ARE REQUIRED FOR ALL PASSENGERS ON SOME REGULATED TRAILS.

X MR / XT-P BOLSTER SEATS

- Bolster seat upgrade gives occupants additional support and comfort for recreational riding.
- Features added side padding and redesigned profile to help you control and enjoy your side-by-side vehicle to the fullest.
- Reinforced seat skin.
- Compatible with rear seat on MAX models.
- Not compatible with Heated Seat Covers.
- Standard on Traxter X mr and XT-P models.

Traxter, Traxter MAX

- 715004363 • Black / Can-Am Red
- 715004678 • Black / Brown



ADJUSTABLE DRIVER'S SEAT

- Driver seat upgrade that delivers an added 3 in. (8 cm) of forward/rearward adjustability for increased comfort and facilitated ingress/egress.
- Standard feature on XT, XT Cab and Mossy Oak Hunting Edition models.

Traxter, Traxter MAX
715005519



Increase comfort with 3 extra inches (8 cm) of to and fro adjustment

PERFORMANCE



RIDING GEAR
Upgrade your ride with essential clothing, helmets and more.

S3 FRONT HIGH CLEARANCE A-ARM



MASTER ROUGH TERRAIN—INCREASE THE SPACE BETWEEN LOWER A-ARMS FOR MORE CLEARANCE OVER LARGE OBSTACLES.

S3 FRONT HIGH CLEARANCE A-ARM

- Prevents A-Arm damage over rough terrain.
- Preserves factory ride quality and turning radius without reducing performance.
- Not compatible with Apache 360 LT Track System and Front A-Arm Protectors.
- "S3 for Can-Am" branded.

Contact your authorized dealer or visit our online store at can-amoffroad.com

- 715003784 • Black

- 715005116 • Sunburst Yellow



S3 REAR HIGH CLEARANCE A-ARM

- Prevents A-Arm damage over rough terrain.
- Preserves factory ride quality and turning radius without reducing performance.
- Not compatible with Apache 360 LT Track System and Rear A-Arm Protectors.
- "S3 for Can-Am" branded.

Contact your authorized dealer or visit our online store at can-amoffroad.com

- 715003785 • Black

- 715005118 • Sunburst Yellow



NEW BRAKE HOLDING MECHANISM

- Maintains constant pressure on the brake pedal to keep the vehicle from moving on sloped terrain, without having to put the transmission in P (park).

Traxter, Traxter MAX



GRIP LIKE NEVER BEFORE



Can-Am exclusive:
Respond to Off-Road conditions like never before with 4WD powered by Smart-Lok™ Technology.

Smart-Lok™ is the most advanced Off-Road differential at your command. It's a fully lockable on-the-fly front differential with electronically controlled automatic modes that always returns maximum traction in every condition, period.



CLOSED COURSE DEDICATED FOR MUD RIDING.

1 START WITH THE SMART-LOK™ DIFFERENTIAL

SMART-LOK™ DIFFERENTIAL

- Can-Am-exclusive Smart-Lok™ technology constitutes a true full lockable on-the-fly front differential with electronically controlled automatic modes.
- Choose your differential settings according to your riding need: "2x4" for rear wheel traction only, "4x4 Front Diff Lock" for a fully locked 4 wheel drive, and "4x4 Smart Modes" that offer preset, intelligent calibrations for your type of riding.
- Using multiple input sources, "Smart Modes" will instantaneously engage locking with the right load at the right moment to procure maximum traction while retaining low-speed maneuverability, allowing for optimal placement and a feeling of confidence.
- The Smart-Lok™ Kit comes standard with the Trail Mode.
- Requires Performance Half Shafts (2x) and Front Differential Kit for installation.

Traxter, Traxter MAX (2019 & prior)
705402371



2 GET THE SMART-LOK™ INSTALLATION KIT & PERFORMANCE HALF SHAFT

SMART-LOK™ INSTALLATION KIT

- (Not illustrated)
- Includes all necessary hardware and wiring for Smart-Lok™ Differential installation.

Traxter, Traxter Max (2018 & prior)
715005331

Traxter, Traxter Max 2019
715005332



PERFORMANCE HALF SHAFT

- High-performance design ideal for Off-Road use, with superior wheel power and acceleration for racing, dunes and desert riding.
- Includes CVs, Shaft and Boots with the best suited geometry for your Can-Am vehicle.

Traxter and Traxter Max (2019 & prior - except X mr, XT-P and XT CAB 2018 & up)
705402353

Traxter, Traxter MAX XT Cab 2018-2019, Lone Star Edition 2019 & prior
705402458



3 FINE-TUNE YOUR RIDING ENVIRONMENT WITH A SMART MODE MODULE (OPTIONAL)

These modules allow you to add the **Mud, Rock or Trail Activ** Smart Mode to vehicles equipped with the Smart-Lok™ Differential Kit.
• Only one Smart Mode Module can be installed at a time.



- Designed to deliver superior traction in the deepest mud holes.
- When high engine torque and/or slippage is detected, Smart-Lok™ will fully lock the front end.
- The system will stay locked until throttle release.

MUD SMART MODE MODULE

Models with Smart-Lok™ Differential
715005282



- Designed to help cross challenging rocks.
- When high engine torque is detected at low vehicle speed, Smart-Lok™ will progressively lock the front end and will stay engaged until throttle release to prevent wheel slippage and provide optimal traction.
- The progressive engagement allows for easier steering when maneuvering the vehicle.

ROCK SMART MODE MODULE

Models with Smart-Lok™ Differential
715005283



- Designed for aggressive riding delivering the ultimate cornering precision.
- When high engine torque and/or an increase in vehicle speed is detected, Smart-Lok™ will progressively engage the front end and maintain it engaged until throttle release or vehicle speed reduction.
- The progressive engagement allows for lower smooth steering effort.

TRAIL ACTIV SMART MODE MODULE

Models with Smart-Lok™ Differential
715005284

SNORKEL KIT

- Raises point of engine and CVT air intakes so vehicle can be semi-submersed in water/mud without taking in water to the engine.
- Not compatible with Headache Racks, Gear Rail equipment, DragonFire Cargo Bed Roll Bar and Windshield Wiper & Washer Kit.
- Snorkel Extension Kit is available for roof level air intake and CVT exhaust.
- Adapter for Snorkel Kit (715004414) and Sealed Air Box (707800714) are required for installation on 2017 and prior models.
- Standard on Traxter X mr models.

Traxter, Traxter MAX (except Traxter PRO)
715003727



ADAPTER FOR SNORKEL KIT

- (Not illustrated)
- Required for the installation of Snorkel Kit (715003727) on Traxter 2017 and prior models.
 - Includes rear firewall for Snorkel Kit and hardware.
 - Standard on Traxter 2018 and up models.

Traxter and Traxter MAX 2017 & prior
715004414

SNORKEL EXTENSIONS

- Extend the Snorkel Kit for roof engine and CVT air intake.
- Add aggressive look to your vehicle and help keep your intakes clear from mud, snow, dust, etc. in severe riding conditions.
- Not compatible with all rear panels and windows, Rear Cargo Light and roof-mounted Rear View Camera.
- Snorkel Kit (715003727) is required, except for X mr models.

Traxter, Traxter MAX
715004415



SEALED AIR BOX

- (Not illustrated)
- Required when installing the Snorkel Kit (715003727) on Traxter and Traxter MAX 2017 and prior models.
 - Standard on Traxter 2018 and up models.

Traxter, Traxter MAX 2017 & prior
707800714



BELIEVE IT: YOUR TRAXTER IS A FEW MODS AWAY FROM BEING A TRUE MUD-READY MONSTER.

AIR INTAKE PRE-FILTER

- Adds extra protection to your engine in harsh riding conditions.
- Helps keep air filter cleaner.
- Filter blocks particles larger than 0.007" (0.19 mm).
- Easy, tool-less installation.
- Necessary to maintain vehicle warranty when tracks are installed.
- Required to install the Apache and Backcountry Track Systems.



Traxter (except X mr models), Traxter MAX
715003483

EMERGENCY KIT

- Complete emergency kit provides all essential equipment and supplies to get out of most unfavorable situations powersport enthusiasts can find themselves in.
- Includes: Jumper Cables, Air Compressor, Tire Repair Kit, First Aid Kit, Ratchet Tie-Down, Duct Tape, Tow Strap 3,300 lb (1,500 kg), Zip-Ties, Cloth Rags.

Traxter, Traxter MAX
715004359

SNORKEL PRE-FILTER

- Pre-filter specifically for snorkels.
- Adds extra protection to your engine in harsh riding conditions.
- Helps keep air filter cleaner.
- Filter blocks particles larger than 0.005" (0.13 mm).
- Necessary to maintain vehicle warranty when tracks are installed.

Traxter, Traxter MAX (except Traxter PRO)
715005597



HEAVY-DUTY SPRING KIT

- This set of heavy-duty springs will stiffen your suspension.
- Perfect for reducing vehicle overall sag when shocks are under heavy demand: heavy loading and hauling or for snow clearing.
- Complete kit of 4 springs.
- Not compatible with Traxter HD5, XT CAB, Mossy Oak Edition & X mr models and Traxter Max.

Traxter (2019 & prior), Traxter HD8 (2020 & up)
715005084



FRONT HEAVY-DUTY SPRINGS

- This set of heavy-duty springs will stiffen your suspension.
- Perfect for reducing vehicle sag on heavy jobs like snow clearing or heavy load hauling.
- Sold in pairs.

Traxter (2018 & prior, Base, DPS & XT models only)
715002450

Traxter MAX (2018 & prior, Base, DPS & XT models only)
715004280

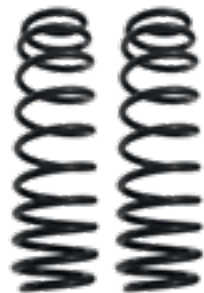

FOAM AIR FILTER BY TWIN AIR[†]

- The best choice for the harshest conditions.
- Multiple staged oiled filtering foam for superior dust retaining capacity with high air flow.
- Washable and reusable.

Traxter, Traxter MAX
715003630



APACHE TRACK SYSTEMS



EACH TRACK HAS A SPECIFIC PURPOSE AND IS DESIGNED WITHOUT COMPROMISE FOR WORK AND PLAY. WHETHER IT'S FOR DEEP SNOW RIDING, TRAIL RIDING OR FOR HEAVY LOADS, APACHE TRACKS ARE AKIN TO FLOATING ACROSS THE TERRAIN.

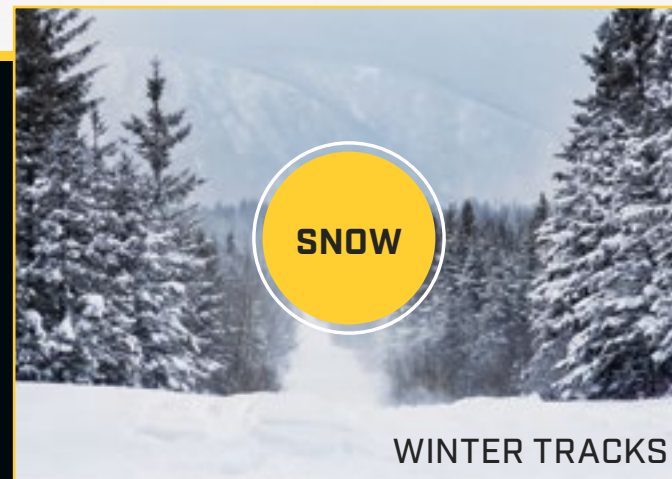

WINTER TRACKS

APACHE BACKCOUNTRY

Finally explore winter with no traction limitations and no compromise, thanks to the unmatched performance of Apache Backcountry track kits. Engineered to thrive in the deepest snow—for work or play. Don't let winter stand in the way.



YEAR-ROUND TRACKS

APACHE 360, 360 LT

These track kits improve your vehicle's ground clearance and increase its contact patch with the terrain. Adapt your track setup to the conditions you'll be riding in and the purpose of your ride, with the Apache 360 and 360 LT systems: as our all-season, all-terrain masterpieces.

WINTER TRACKS

GET THE MOST OUT OF YOUR CAN-AM VEHICLE THIS WINTER FOR ALL YOUR ENDEAVORS.

Explore without compromise. Ride on untouched trails, traveling deep into winter's embrace and you'll know: The same technology behind our world-renowned snowmobiles is at your command. With a larger contact patch, and more aggressive track design, travel beyond what you thought possible with the best snow performance.

COVERED BY A
1-YEAR WARRANTY

YEAR-ROUND TRACKS

WORK & PLAY YEAR ROUND THROUGH MUD, SNOW, & ALL TYPES OF TERRAIN.

Rise above terrain, weather, and whole seasons with the Apache 360 LT track kit—the upgrade that takes the Can-Am experience to another level. Designed for superior traction and carrying heavier loads in soft terrain, the 360 LT track kit can be installed on ATV and SSV vehicles and used year round for exploring and completing tough tasks.

COVERED BY A
2-YEAR WARRANTY

APACHE BACKCOUNTRY

Efficient frame and rail design ensures weight is evenly distributed

Added ground clearance of 6.4" (16.2 cm)

Aggressive track design with a 2" (5 cm) lug height for maximum traction

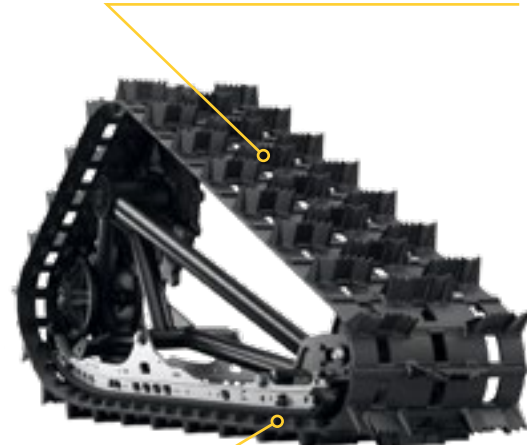
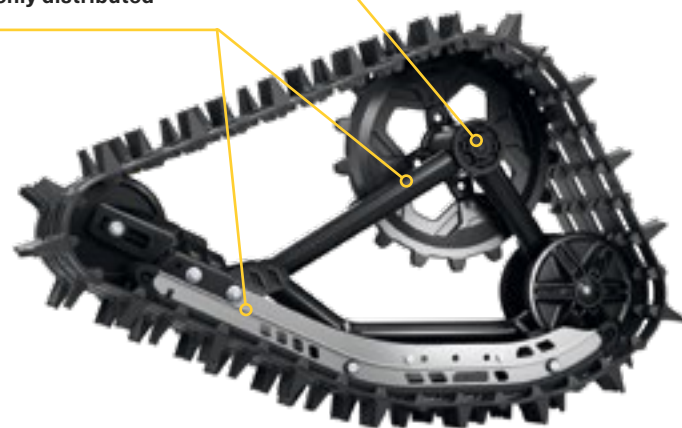

Largest contact patch anywhere: 37% more than the Apache 360 LT

APACHE BACKCOUNTRY LT TRACK KIT

- Tracks designed to deliver the best snow performance on the market with unmatched flotation level and traction on snow surface.
- Large contact patch, 37% bigger than the Apache 360 LT.
- Impressive added ground clearance of 6.4" (16 cm) helps keep the vehicle over the snow.
- Lightweight snowmobile-inspired rail design.
- Aggressive track design with 2" (5 cm) lug height for maximum traction on snow.
- Apache Backcountry LT Mounting Kit, Track DPS Module and Engine & CVT Pre-Filter are required.
- Fine-tune your track system using extra Idler Wheels, Sliders with Vespel Inserts and Rail Ice Scratcher.
- For winter use only.

Traxter, Traxter MAX
715005891

APACHE BACKCOUNTRY LT MOUNT KIT

- (Not illustrated)
- Required for installation of the Apache Backcountry LT Track System.
 - DPS module and Pre-Filter are required and sold separately.

See table p. 68 for fit, compatibility and requirements.

715005888 715005493 715006196

APACHE 360 LT

Added ground clearance of 4.5" (11.4 cm)

Quick & easy installation

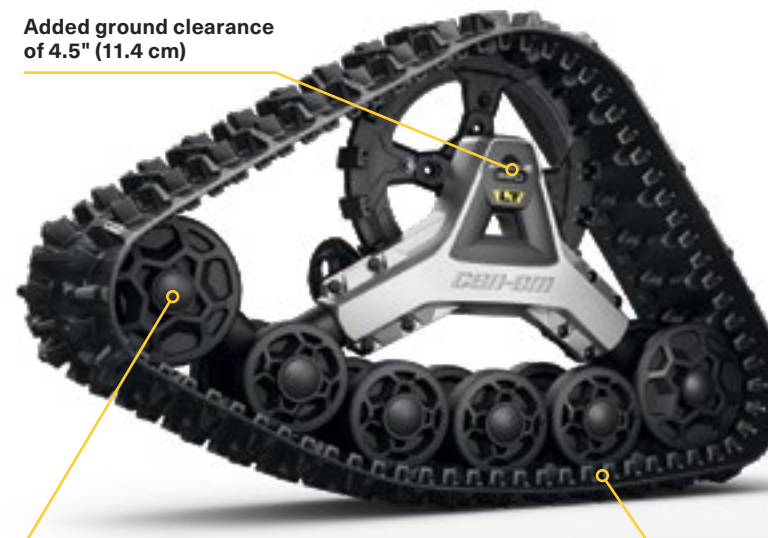

Unique adjustable contact patch system to tackle the toughest year-round conditions



Rubber over molded heavy-duty double bearing wheels and offset wheel spacing reduce friction and vibration while ensuring reliability

Total ground surface area of 2,473.7 in² (14,784 cm²)

APACHE 360 LT TRACK SYSTEM

- Multifunctional tracks designed to support heavy loads and to fit on most Can-Am Off-Road vehicles.
- Extra contact patch adjustment for better performance over rough terrain.
- Contact patch is 7 to 9% bigger than the Apache 360's.
- Average ground clearance increase of 4.5" (11.44 cm).
- 1" (2.5 cm) lugs in the front and 1.25" (3.2 cm) in the back.
- Apache 360 LT Mounting Kit is required.

Traxter, Traxter MAX
715005103

APACHE 360 LT MOUNTING KIT

- (Not illustrated)
- Required to install Apache 360 LT Track System (715003064).
 - Track DPS Module and Air Intake Pre-Filter not included.

See table p. 68 for fit, compatibility and requirements.
715004831 715005492
715004832

RAIL ICE SCRATCHERS

Provide additional lubrication in hard and icy conditions and extends slider life. Rail mounted, small, light. Design expands on coil concept to allow reversing without damage. Easily stored when not in use.

Apache Backcountry Track System
860201728



NEW EXTRA WHEEL KIT

- Additional wheel kit for Backcountry LT rear tracks.
- Reduces drag and rolling resistance in hard snow conditions or when transporting heavier loads.
- Extends slider life in hard snow conditions.
- Includes two wheels, cross shaft and mounting hardware per kit to service one track corner.
- Up to two kits per rear track can be installed.

Apache Backcountry LT Wheel kit
715006293



TRACK DPS MODULE

- (Not illustrated)
- An innovative DPS module that ensures speedometer accuracy and optimized steering assist, which make for perfect track control and riding ease.
 - Required to install the Apache and Backcountry Track Systems.
 - Not sold in Europe.

715004707

AIR INTAKE PRE-FILTER

- Adds extra protection to your engine in harsh riding conditions.
- Helps keep air filter cleaner.
- Filter blocks particles larger than 0.007" (0.19 mm).
- Easy, tool-less installation.
- Necessary to maintain vehicle warranty when tracks are installed.
- Required to install the Apache and Backcountry Track Systems.
- Not compatible with Snorkel kit.

Traxter, Traxter MAX
715003483



SNORKEL PRE-FILTERS

- Pre-filter specifically for snorkels.
- Adds extra protection to your engine in harsh riding conditions.
- Helps keep air filter cleaner.
- Filter blocks particles larger than 0.005" (0.13 mm).
- Necessary to maintain vehicle warranty when tracks are installed.

Traxter, Traxter MAX
715005597



CVT AIR INTAKE RELOCATION KIT

- Relocates the CVT air intake protected in the cab area.
- Keeps the CVT air intake away from snow splashing from wheels or tracks.
- Highly recommended for track-equipped vehicles.

Traxter (except X mr and PRO models), Traxter MAX
715004183





QUICK REFERENCE FITTING GUIDE							
Track System	Model Year	Model	Track	Track Mount	DPS*	Pre-filter without snorkel	Pre-filter with Snorkel
APACHE BACKCOUNTRY LT	2019 & Prior	Traxter Base, DPS, XT, XT Cab 2017 & Hunting Edition, XT-P	715005891	715005888	715004707	715003483 715004183 (except X mr)	715005597 (and X mr)
	2019 & Prior	Traxter XT Cab 2018-2019, Lonestar Edition & X mr		715006196			
	2020 & +	Traxter Base, DPS (HD5 & HD8), XT(HD8)		715005888			
	2020 & +	Traxter DPS (HD10), XT(HD10), XT-P, PRO DPS, PRO XT		715005493			
	2020 & +	Traxter XT cab, XT Cab Limited, Hunting Edition, Lonestar Edition, X mr, PRO Limited, PRO LONESTAR		715006196			
APACHE 360 LT	2019 & Prior	Traxter Base, DPS, XT, XT Cab 2017 & Hunting Edition	715005103	715004831	715004707	715003483 715004183 (except X mr)	715005597 (and X mr)
	2019 & Prior	Traxter XT Cab 2018-2019, Lonestar Edition & X mr		715004832			
	2020 & +	Traxter Base, DPS (HD5 & HD8), XT(HD8)		715004831			
	2020 & +	Traxter DPS (HD10), XT(HD10), XT-P, PRO DPS, PRO XT		715005492			
	2020 & +	Traxter XT cab, XT Cab Limited, Hunting Edition, Lonestar Edition, X mr, PRO Limited, PRO LONESTAR		715004832			

Vehicle width and length will be affected by tracks installation.
*Not sold in Europe.

NEW APACHE BACKCOUNTRY LT WHEEL KIT

- Additional wheel kit for Backcountry LT rear tracks.
- Reduces drag and rolling resistance in hard snow conditions or when transporting heavier loads.
- Extends slider life in hard snow conditions.
- Includes two wheels, cross shaft and mounting hardware per kit to service one track corner.
- Up to two kits per rear track can be installed.

Apache Backcountry LT Track System
(715005891 and 715004734)
715006293



REAR TIRE CHAINS

- Improve your traction in mud and snow.
- Sold in pairs.

27" x 9"x 14"
715003839

29" x 9"x 14"
715000225



PROMOUNT PLOWS



THE PROMOUNT LINEUP WAS CREATED FOR BOTH PROFESSIONAL OPERATORS AND ENTHUSIASTS LOOKING TO TAKE THEIR TOOL KIT TO THE NEXT LEVEL. DESIGNED TO WORK AS EFFICIENTLY AS POSSIBLE, CAN-AM REIMAGINED THE PLOW FROM MOUNT TO BLADE.

MOST EFFICIENT MOUNTING SYSTEM

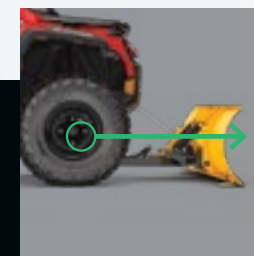

Underbelly mounting plate provides the optimal angle of attack for best push strength.

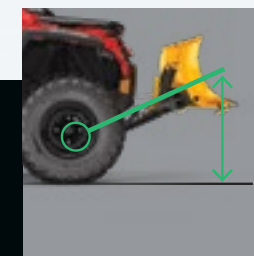

The forward mounted push frame provides industry leading lift height.



Low profile mounting plate has little impact on ground clearance and can be left installed year round.

CONNECTS WITH A CLICK

Attachable in **FOUR EASY STEPS**, the Can-Am ProMount plow system is the fastest, easiest way to start plowing and get the job done—minimal effort for maximum result.

1

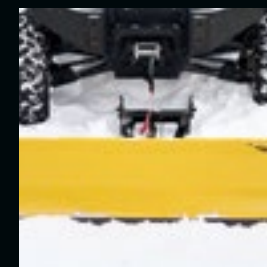

Drive straight toward the plow.

2

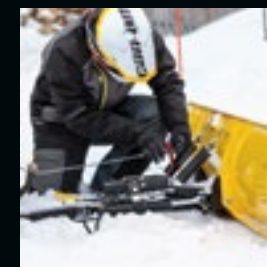

Attach the winch cable to the plow using a guiding hook/roller.

3



Lift the plow until it clips onto the mounting plate.

4

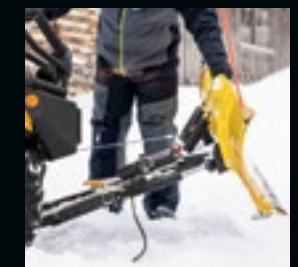

Remove the winch cable from the guide. You're ready to plow.

CAN-AM PROMOUNT FLEX2 PLOWS

HMWPE (High Molecular Weight Polyethylene) technology gives Flex2 greater reliability, resistance to impact, and immunity to rust or deformation. Tough on jobs but flexible in the face of obstacles, the Flex2 blade simplifies work.

CAN-AM PROMOUNT FLEX2 PLOW KIT

- These kits include:**
- Can-Am ProMount Flex2 Blade
 - Push Frame with Quick-Attach System
 - Mounting Plate

72" BLADE

- Traxter, Traxter MAX**
- 715006301 Black



CAN-AM PROMOUNT FLEX2 BLADE

- Blades available individually to create your own kit.
- Compatible with Can-Am ProMount Blade accessories to further enhance plow versatility.

72" BLADE*

- Clears 66" (168 cm) when plow is fully angled.
- Blade height of 17" (43 cm).

ProMount Push Frame

- 715004485 • Black



72" (183 cm)

CREATE YOUR OWN KIT

by choosing any plow type/length that you'd like for your push frame. **ProMount Push Frames are compatible with all the blades.**

CONSULT YOUR DEALER FOR THE BEST PLOW WIDTH.

Made from 12-gauge steel and designed for efficient plowing, the ProMount steel blades are offered in multiple sizes to fit jobs large or small.

CAN-AM PROMOUNT STEEL PLOWS

Made from 12-gauge steel and designed for efficient plowing, the ProMount steel blades are offered in multiple sizes.

CAN-AM PROMOUNT STEEL PLOW KITS

- These kits include:**
- Can-Am ProMount Steel Blade
 - Push Frame with Quick-Attach System
 - Mounting Plate

72" BLADE

- Traxter, Traxter MAX**
- 715006302 Black
 - 715006303 Yellow



72" (183 cm)

CAN-AM PROMOUNT STEEL BLADES

- Blades available individually to create your own kit.
- Compatible with Can-Am ProMount Blade accessories to further enhance plow versatility.
- Not compatible with S3 Front High Clearance a A-Arm (715003784 & 715005116).



72" BLADE*

- Clears 66" (168 cm) when plow is fully angled.
- Blade height of 17" (43 cm).

ProMount Push Frame

- 715004474 Black
- 715006021 Yellow

66" BLADE*

- Clears 60" (152 cm) when plow is fully angled.
- Blade height of 17" (43 cm).

ProMount Push Frame

- 715006337 Black
- 715006338 Yellow

CREATE YOUR OWN KIT

by choosing any plow type/length that you'd like for your push frame. **ProMount Push Frames are compatible with all the blades.**

CONSULT YOUR DEALER FOR THE BEST PLOW WIDTH.

Made from 12-gauge steel and designed for efficient plowing, the ProMount steel blades are offered in multiple sizes to fit jobs large or small.

CAN-AM PROMOUNT ANGLE PLOWS

NEW CAN-AM ANGLE BLADES

- Make the job easier with the right tools, clear long alleys and make the task easier by sending the snow further out of the way.
- Wing end of plow measures 25" (63 cm) high and tapers down to 16" (41 cm).
- One-way "winged" state plow designed to throw snow higher.
- Rubber flap designed to keep snow away from the driver.
- Can-Am branded.

72" (183 CM) STEEL ONEWAY STATE BLADE

■ 715007264 • Black

66" (168 CM) STEEL ONEWAY STATE BLADE

■ 715007263 • Black



YOUR JOB, YOUR CHOICE

Get a custom solution that truly fits the task at hand—with quality components and no cut corners. The ProMount mounting plate, push frame, and blades are a universal system that can be adapted to your specific Can-Am and jobsite.

CAN-AM PROMOUNT PUSH FRAME WITH QUICK-ATTACH SYSTEM

- Heavy-duty steel tubes designed to withstand the roughest use.
- Mid-mount carriage provides ultimate push strength and traction.
- Designed for maximum plow lift height.
- Features a self-aligning quick-attach system, an easy foot release pedal and an ergonomic handle for plow angle adjustment.
- Plow Roller Fairlead and Plow Limit Switch recommended to extend winch cable lifespan.
- Can-Am ProMount Mounting Plate required for installation.
- Blade swivels left or right, 5 positions.
- Large pin designed for easy blade rotation to eliminate dirt and snow buildup at pivot point.

Traxter, Traxter MAX
715003910



CAN-AM PROMOUNT MOUNTING PLATE

- Required to install the Can-Am ProMount Push Frame with Quick-Attach System.
- Mounting plate precision-designed to stay on year round without compromising ground clearance.
- Not compatible with S3 Front High Clearance A-Arm (715003784 and 715005116).

Traxter, Traxter MAX
715004484



PUSH FRAME EXTENSION

- 12" (30 cm) push frame extension required when plow is installed with Apache Track Systems.

Traxter, Traxter MAX
715006257



CREATE YOUR OWN KIT

by choosing any plow type/length that you'd like for your push frame. **ProMount Push Frames are compatible with all the blades.**

CAN-AM PROMOUNT PLOW ACCESSORIES



1 CAN-AM PROMOUNT EDGE MARKERS

- Help locate the edges of your plow.
- Height: 24" (60 cm).
- Sold in pairs.
- Compatible with Can-Am ProMount Steel and Flex2 Blades with or without Blade Extensions (except for the Can-Am ProMount Steel 54" (137 cm) Blades).

ProMount System
715004206

3 CAN-AM PROMOUNT DRIFT CUTTERS*

- Help keep snow in the plow.
- Dimensions: 17" x 13" (43.2 cm x 33 cm).
- Sold in pairs.
- Compatible with Can-Am ProMount Steel and Flex2 Blades with or without Blade Extensions (except for the Can-Am ProMount Steel 54" (137 cm) Blades).

ProMount System
715006258

2 CAN-AM PROMOUNT PLASTIC WEAR BLADE*

- To help prevent scratches on smooth driveways and markable surfaces.

ProMount System
66" (168 cm) 72" (183 cm)
715004482 715004483

4 CAN-AM PROMOUNT BLADE EXTENSIONS

- Add 3" (8 cm) each side.
- Compatible with Can-Am ProMount Blades (except for Can-Am ProMount Steel 54" [137 cm] Blade).
- Longer Wear Blade can be installed to further extend the extra length already provided by the extensions.
- Compatible with Can-Am ProMount Steel and Flex2 Blades (except for the Can-Am ProMount Steel 54" [137 cm] Blades).

ProMount System
■ 715004205 • Black
■ 715005319 • Yellow

PLOW ANGLING SYSTEM*

- Converts your plow system into an easy-to-control unit from the driver's seat.
- Allows you to have full up/down and left/right plow control at your fingertips by using the supplied joystick.
- Using one hand to control all plow motions will allow you to easily concentrate and manage your plowing tasks.
- Push Frame Extension (715006257) is required for installation with the Front Rancher Bumper.
- Not compatible with Apache Backcountry Track System.

Any ProMount Push Frames and Blades
715006022



PLOW ROLLER FAIRLEAD

- Larger diameter lower roller reduces wear on wire rope for plow application.
- Can be used with all ProMount plows.

Traxter, Traxter MAX
705203753



PROMOUNT PLOW LIMIT SWITCH

- (Not illustrated)
- For controlling the cable tension when over raising your plow system.
 - Prevents winch, plow push frame and vehicle damage.
 - Sensor relocated for optimal lift height.

Traxter, Traxter MAX
715006259

SUPER-DUTY PLOW SYSTEM

The Super-Duty plow system and attachments are built to maximize your Traxter's capabilities. Built to be extremely robust, efficient at tackling heavy jobs, and resistant to regular use—we call it "super" for a reason.

SUPER-DUTY PLOW KITS

- A comprehensive plow system with manual lift and angling.
- Ultra-durable 72" (183 cm) blade made of 12-gauge steel with integrated reinforcement and heavy-duty push tubes to tackle the most demanding jobs.
- Requires a winch for raising and lowering.
- Convenient disconnect system for quick and easy installation or removal.
- Front mount provides minimum 11" (28 cm) lift distance.

This kit includes:

- 72" (183 cm) Super-Duty Plow
- Super-Duty Plow Push Frame
- Super-Duty Plow Mounting Kit

72" (183 CM)

Traxter, Traxter MAX
715003416



Shown with the following accessories:

- Plow Rubber Flap (715001219)
- Plow Drift Cutter (715001218)
- Plow Edge Markers (715001216)

SUPER-DUTY PLOW HYDRAULIC ANGLING KIT

- Allows you to have full up/down and left/right plow control at your fingertips.
- Pre-assembled, it comes with everything you need to turn your Super-Duty Plow into a quick, easy-to-control unit from the driver's seat.
- Using one hand to control all plow motions with the supplied joystick will allow you to easily concentrate and manage your plowing tasks.
- With this commercial grade kit, you will send snow exactly where you want reliably all winter long.
- Winch and plow sold separately.

Traxter, Traxter MAX (2019 & prior)
715002840



Cylinders hydraulic



Electric hydraulic unit

Traxter, Traxter Max (2020 & up)
715006038

SUPER-DUTY PLOW PUSH FRAME EXTENSION

- (Not illustrated)
- Extension to use the Super-Duty Plow with the Apache 360 LT Track System.
 - Comes with Plow Magnetic Switch and Plow Pulley.
 - Requires Front Bumper or Front Accessory Bar for installation.

Super-Duty Plow
715001221 Black

PLOW BLADE EXTENSIONS

- Side extensions for widening your plow blade by 6" (15 cm) on each side.
- Include rubber flaps for extension parts.
- Sold in pairs.

Super-Duty Plow
715001217



PLOW EDGE MARKERS

- (Not illustrated)
- For a more accurate view of the width of your plow.
 - Allows you to work closely around objects.

Super-Duty Plow
715001216

PLOW DRIFT CUTTER

- (Not illustrated)
- Keeps snow securely in the plow.
 - Allows you to cut a cleaner pass.
 - Sold individually.

Super-Duty Plow
715001218

PLOW RUBBER FLAP

- (Not illustrated)
- Keeps snow away from the driver and helps snow to roll in front of the plow.

Super-Duty Plow
715001219

PLOW PULLEY

- (Not illustrated)
- For use with the Super-Duty Plow.
 - Helps winching efficiency.
 - Requires Front XT Bumper.

Super-Duty Plow
715002042

PLOW MAGNETIC SWITCH

- (Not illustrated)
- Magnetic switch that stops the winch to prevent cable, winch and frame damage.
 - For use with Super-Duty Plow.

Super-Duty Plow
715001995

COVERS & ADD-ONS

TRAILERING COVER

- Heavy-duty canvas made of UV-resistant solution-dyed polyester.
- Inner soft liner protects windshield and colored panels from abrasion.
- All high-abrasion areas are reinforced with a double canvas layer.
- Weather-resistant trailering cover protects your vehicle during storage and transportation.
- Opening for fuel cap.
- Quick and easy installation.
- Designed to perfectly fit your vehicle with or without Can-Am accessories.

Traxter
715004453

Traxter MAX, Traxter PRO
715004454



BOLT-ON⁺ RETRACTABLE RATCHETING TIE-DOWNS

- Perfect for transporting your powersport vehicle or securing loads.
- Mounts easily: Bolts on any flat surface (e.g., truck bed or frame).
- 1" x 6' (2.5 cm x 1.8 m) tie-down strap with heavy-duty stitching that delivers a 500 lb (226 kg) working load strength and 1,500 lb (680 kg) break strength.
- Convenient retractable push button automatically slackens, spools and stores away strap, while the ratchet mechanism tightens the strap snugly to secure your vehicle or load into place.
- Rubber ratcheting handle provides firm grip, and the hook is vinyl coated to protect whatever surface it hooks into.
- Sold in pairs.

295100737



RATCHET TIE-DOWNS

- 400 lb (181 kg) safe working load.
- 1" x 10' (2.5 cm x 3 m) strap with Sea-Doo, Ski-Doo and Can-Am logos.
- Deluxe ratchet with rubber handle.
- Coated S hooks.
- Pack of 2.

860200447 Black/Grey



SCS WRAP KITS: PERFECTLY-SIZED AND EXCLUSIVE WRAP DESIGNS* THAT WILL COMPLEMENT YOUR TRAXTER AND REFRESH ITS LOOK. YOU'RE UNIQUE. YOUR RIDE SHOULD BE TOO.

Available at participating Can-Am dealers and scscanamgraphics.com

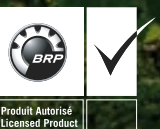

*SCS wraps are of the highest quality, made with 0.004" (0.01 cm) engineering-grade vinyl overlaid with a 0.008" (0.02 cm) UV-protective laminate. That means vibrant colors, easy installation and a wrap that will hold up to the rigors of the Off-Road. SCS can even customize the color combinations; adding names, numbers and logos according to your exact specifications. Available for both 2-seat and 4-seat Traxter models.

TIRES & RIMS



WITHOUT TRACTION, THERE'S NOTHING—FIT THE BEST TIRES AND WHEELS ON YOUR TRAXTER AND SEE ALL IT CAN DO.

RIMS

14" RIM

- Black with clear coat aluminum rim.
- Choice of beadlock color (not included).
- Needs 16 bolts (250000435) for installing the beadlock.

Traxter, Traxter MAX
 Front - 14" x 6.5" offset = 41 mm
705401594

Rear - 14" x 8" offset = 51 mm
705502146



14" BEADLOCK RINGS

- Cast aluminum beadlock.
- Must be installed on Front Rim (705401594) and Rear Rim (705502146).

Traxter, Traxter MAX
 ■ 705401586 · Manta Green
 ■ 705401702 · Octane Blue
 ■ 705401837 · Can-Am Red
 ■ 705401840 · Black

12" RIM

- Black with clear coat aluminum rim.
- Choice of beadlock color (not included).
- Needs 16 bolts (250000435) for installing the beadlock.

Traxter, Traxter MAX
 Front - 12" x 6" offset = 41 mm
705401678 · Black

Rear - 12" x 7.5" offset = 51 mm
705502244 · Black



12" BEADLOCK RINGS

- Cast aluminum beadlock.
- Must be installed on Front Rim (705401678) and Rear Rim (705502244).

Traxter, Traxter MAX
 ■ 705401816 · Can-Am Red
 ■ 705401815 · Orange Crush
 ■ 705401814 · Yellow
 ■ 705401695 · Octane Blue

OUTLANDER X MR AND TRAXTER RIM

- Cast aluminum rim with trendsetting explosive styling so you can ride – and look – like a trailblazer.

Traxter, Traxter MAX (front wheels)
 Front - 14" x 6.5" offset = 10 mm
 ■ 705401848 · Black and machined
 ■ 705401849 · Black

Traxter, Traxter MAX (rear wheels)
 Rear - 14" x 8.5" offset = 23 mm
 ■ 705502397 · Black and machined
 ■ 705502398 · Black



NOTE:
 Matching Nuts - 250100184 Black, 250100185 Chrome
 Matching Cap - 705401541

TIRES

ITP CRYPTID

- Graduated lug height and paddle-like shoulder configuration provide maximum side bite for climbing in and out of the mud without compromising ride comfort on trails and hard pack.
- 6-ply rated.

Traxter X mr
 Front - 30" x 9" x 14"
705402504

Rear - 30" x 11" x 14"
705502913



MAXXIS BIGHORN 2.0 TIRE

Traxter (XT, XT Cab)
 Front - 27" x 9" x 14"
705402168

705400961 · CE
 Rear - 27" x 11" x 14"
705502665

705501295 · CE



Traxter
 Front - 27" x 9" x 12"
705402560

705401386 · CE
 Rear - 27" x 11" x 12"
705502938

705501818 · CE
 Front - 28" x 9" x 14"
705402080

Rear - 28" x 11" x 14"
705502603

MAXXIS M923J / M924J

Traxter (Base & DPS models only)
 Front - 25" x 8" x 12"
705402107

Rear - 25" x 10" x 12"
705502626



NOTE:
 Matching Nuts - 250100184
 Matching Cap - 705400928

TRAXTER CAST-ALUMINUM 14" RIM

Traxter, Traxter MAX
 Front - 14" x 7" offset = 41 mm
705402338 · Black

Rear - 14" x 8.5" offset = 51 mm
705502778 · Black

NOTE:
 Matching Nuts - 250100184
 Matching Cap - 705401541

NOTE:
 Matching Nuts - 250100184
 Matching Cap - 705400928

LONE STAR CAST-ALUMINUM 14" RIM

Traxter, Traxter MAX
 Front - 14" x 7" offset = 41 mm
705402334

Rear - 14" x 8.5" offset = 51 mm
705502775

NOTE:
 Matching Nuts - 250100184
 Matching Cap - 705401541

TRAXTER RIM

(Not illustrated)
 Front - 14" x 7" offset = 41 mm
 ■ 705402120 · Black

■ 705402118 · Silver and machined
 ■ 705402121 · Black and machined

Rear - 14" x 8.5" offset = 51 mm
 ■ 705502637 · Black

■ 705502634 · Silver and machined

■ 705502635 · Black and machined

NOTE:
 Matching Nuts - 250100184 Black, 250100185 Chrome
 Matching Cap - 705401541

*Consult your operator's guide/owner's manual for proper tire type and rim sizing. Improper tire type and rim selection may affect vehicle handling. Check with your local authorities for proper regulation.

*Consult your operator's guide/owner's manual for proper tire type and rim sizing. Improper tire type and rim selection may affect vehicle handling. Check with your local authorities for proper regulation.

APPAREL

Clothing, helmets, glasses and everything else you need to shift your Can-Am experience into high gear.

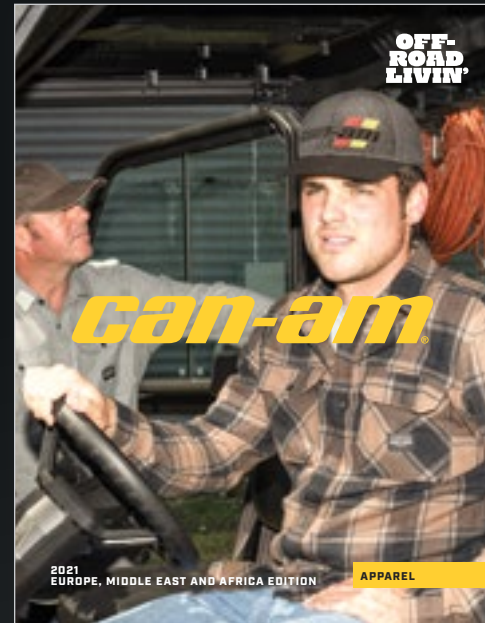

PARTS & MAINTENANCE

Essential items to keep your Can-Am tearing up the tarmac, including oils, filters maintenance products and cleaning products.



EXPLORE AN ENTIRE WORLD OF ADVENTURE WITH ALL OF OUR BRP PRODUCTS. BRP.COM



ski-doo LYNX SEA-DOO can-am ROTAX ALUMAcraft Manitou EVIRUDE



CAN-AMOFFROAD.COM

